

1-1-2020

Extremal Khovanov homology of Turaev genus one links

Oliver T. Dasbach
Louisiana State University

Adam M. Lowrance
Vassar College

Follow this and additional works at: https://digitalcommons.lsu.edu/mathematics_pubs

Recommended Citation

Dasbach, O., & Lowrance, A. (2020). Extremal Khovanov homology of Turaev genus one links. *Fundamenta Mathematicae*, 250 (1), 63-99. <https://doi.org/10.4064/fm729-9-2019>

This Article is brought to you for free and open access by the Department of Mathematics at LSU Digital Commons. It has been accepted for inclusion in Faculty Publications by an authorized administrator of LSU Digital Commons. For more information, please contact ir@lsu.edu.

EXTREMAL KHOVANOV HOMOLOGY OF TURAEV GENUS ONE LINKS

OLIVER T. DASBACH AND ADAM M. LOWRANCE

ABSTRACT. The Turaev genus of a link can be thought of as a way of measuring how non-alternating a link is. A link is Turaev genus zero if and only if it is alternating, and in this viewpoint, links with large Turaev genus are very non-alternating. In this paper, we study Turaev genus one links, a class of links which includes almost alternating links. We prove that the Khovanov homology of a Turaev genus one link is isomorphic to \mathbb{Z} in at least one of its extremal quantum gradings. As an application, we compute or nearly compute the maximal Thurston Bennequin number of a Turaev genus one link.

1. INTRODUCTION

1.1. Turaev genus one and almost alternating links. The Turaev surface associated to a link diagram is a closed, oriented surface that has close ties to the Jones polynomial of the link. The Turaev genus $g_T(L)$ of a link L is the minimum genus of any Turaev surface of a diagram of L . Turaev [Tur87] first constructed this surface to give a topological simplification of the proof that the span of the Jones polynomial is a lower bound on the crossing number of the link, which implies Tait's conjecture that reduced alternating diagrams have minimum crossing number.

The Turaev genus of a link can be thought of as giving a filtration on all links where a link with large Turaev genus is qualitatively far away from being alternating. Alternating links are precisely those links with Turaev genus zero, and in this viewpoint, links of Turaev genus one are close to being alternating. Armond, Lowrance [AL17] and independently Kim [Kim18] classified Turaev genus one links by proving that each such link has a diagram as in Figure 10. Using that classification, Dasbach and Lowrance [DL18] proved that either the first or last coefficient of the Jones polynomial of a Turaev genus one link has absolute value one. It is this result that we generalize to Khovanov homology in the present paper. In order to do so, we will need to introduce almost alternating and A - and B -adequate links.

Adams et al. [ABB⁺92] defined an *almost alternating link* to be a non-alternating link with a diagram that can be transformed into an alternating diagram via a single crossing change. Such a diagram is called an *almost alternating diagram*. A generic almost alternating diagram can be decomposed into the crossing that is changed to obtain an alternating diagram, called the *dealternator*, and an alternating 2-tangle R as in Figure 1. Let u_1 and u_2 be the two regions incident to the dealternator \times that are joined by an A -resolution \sphericalangle and let v_1 and v_2 be the two regions incident to the dealternator that are joined by a B -resolution \sphericalleftarrow . Suppose that the regions of the link diagram are checkerboard colored with v_1 and v_2 being colored black, while u_1 and u_2 are colored white.

Definition 1.1. An almost alternating diagram is *A -almost alternating* if it satisfies the following conditions.

- (1) The regions u_1 and u_2 are distinct, and the regions v_1 and v_2 are distinct.

The first author was supported in part by NSF grant DMS-1317942. The second author was supported in part by Simons Collaboration Grant for Mathematicians no. 355087 and NSF grant DMS-1811344.

(2) There is no crossing in R that is in the boundary of u_1 and u_2 , and there is no crossing in R that is in the boundary of v_1 and v_2 .

(3A) There is no white region in R that shares a crossing with each of u_1 and u_2 .

A link with an A -almost alternating diagram is an A -almost alternating link. An almost alternating diagram is B -almost alternating if it satisfies conditions (1) and (2) above as well as condition (3B).

(3B) There is no black region in R that shares a crossing with each of v_1 and v_2 .

A link with a B -almost alternating diagram is a B -almost alternating link.

If an almost alternating diagram fails to satisfy condition (1) or (2), then the link is alternating (see Figure 5). In Theorem 3.4 we show that every almost alternating link is either A -almost alternating or B -almost alternating. See Figure 1 for an example of a generic almost alternating diagram and an A -almost alternating knot.

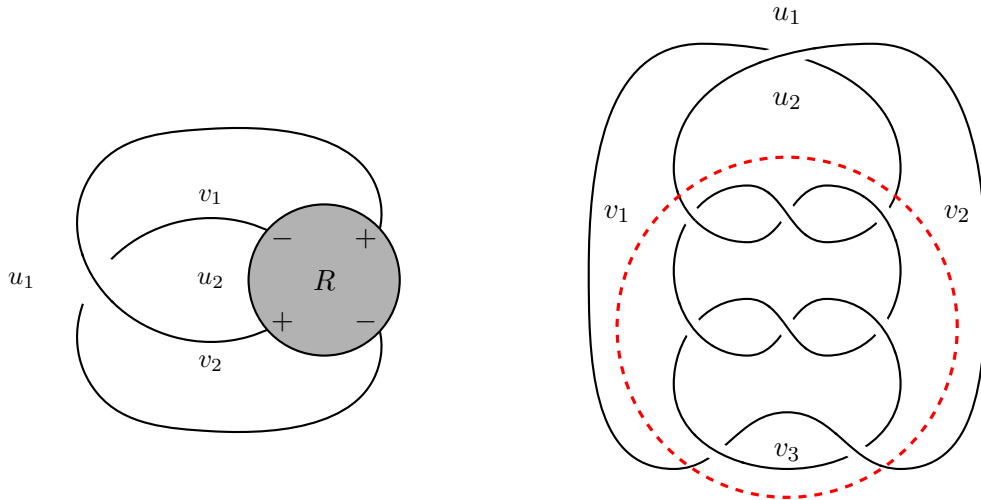

Figure 1: On the left is a generic almost alternating diagram. The 2-tangle R is alternating. A label of $+$ on an incoming strand indicates that strand passes over the first other strand it encounters inside R . Similarly, a label of $-$ on an incoming strand indicates that strand passes under the first other strand it encounters inside R . On the right is an A -almost alternating diagram of a knot K where the alternating tangle R is inside the dashed red circle. The region v_3 shares a crossing with each of v_1 and v_2 , and so the diagram is not B -almost alternating. However no region in the alternating tangle R shares a crossing with each of u_1 and u_2 , and thus the diagram is A -almost alternating.

A *Kauffman state* of D is the set of simple closed curves resulting from a choice at each crossing \times of an A -resolution \succ or a B -resolution \succsim . The state obtained by choosing an A -resolution for every crossing is the *all- A state* of D , and the state obtained by choosing a B -resolution for every crossing is the *all- B state* of D . A link diagram D is *A -adequate* (respectively *B -adequate*) if no two arcs in the A -resolution (B -resolution) of any crossing lie on the same component of the all- A (all- B) state of D . A link is *A -adequate* (respectively *B -adequate*) if it has an A -adequate (B -adequate) diagram. A link diagram that is both A -adequate and B -adequate is called *adequate*, and any link having such a diagram is also called *adequate*. A link that is not adequate, but

has a diagram that is either A -adequate or B -adequate is called *semi-adequate*. A link that has no A -adequate or B -adequate diagrams is called *inadequate*. Lickorish and Thistlethwaite [LT88] introduced adequate links and proved that an adequate diagram of a link has the fewest number of crossings of any diagram of that link.

It is straightforward to check that every almost alternating link has Turaev genus one. Kim [Kim18] proved that every inadequate Turaev genus one link is almost alternating (see Theorem 3.5).

Definition 1.2. A Turaev genus one diagram D is *A -Turaev genus one* if it is A -adequate or A -almost alternating. Likewise, a Turaev genus one diagram D is *B -Turaev genus one* if it is B -adequate or B -almost alternating. A Turaev genus one link L is *A -Turaev genus one* if it has an A -Turaev genus one diagram and is *B -Turaev genus one* if it has a B -Turaev genus one diagram.

Corollary 3.6 states that every Turaev genus one link is either A -Turaev genus one or B -Turaev genus one.

1.2. Extremal Khovanov homology. The Khovanov homology $Kh(L)$ of a link L is a homological generalization of the Jones polynomial of L . It is a \mathbb{Z} -module equipped with two gradings: the homological grading i and the quantum grading j . There is a direct sum decomposition $Kh(L) = \bigoplus_{i,j \in \mathbb{Z}} Kh^{i,j}(L)$ where $Kh^{i,j}(L)$ denotes the summand in homological grading i and quantum grading j . The extremal Khovanov homology of a link refers to the Khovanov homology in the maximum or minimum quantum gradings. Define

$$\begin{aligned} j_{\min}(L) &= \min\{j \mid Kh^{i,j}(L) \neq 0\}, \\ j_{\max}(L) &= \max\{j \mid Kh^{i,j}(L) \neq 0\}, \\ \delta_{\min}(L) &= \min\{2i - j \mid Kh^{i,j}(L) \neq 0\}, \text{ and} \\ \delta_{\max}(L) &= \max\{2i - j \mid Kh^{i,j}(L) \neq 0\}. \end{aligned}$$

For a fixed $j_0 \in \mathbb{Z}$, let $Kh^{*,j_0}(L)$ denote the direct sum $\bigoplus_{i \in \mathbb{Z}} Kh^{i,j_0}(L)$. As a shorthand, we often write $Kh^{*,j_0}(L) = Kh^{i_0,j_0}(L)$ to mean that the Khovanov homology of L in quantum grading j_0 is entirely supported in the single homological grading i_0 . Our main theorem characterizes at least one of the extremal Khovanov homology groups of Turaev genus one, almost alternating, and A - or B -adequate links.

Theorem 1.3. *Suppose that L is a non-split link.*

- (1) *If L is A -Turaev genus one, A -almost alternating, or A -adequate, then there is an $i_0 \in \mathbb{Z}$ such that $Kh^{*,j_{\min}(L)}(L) = Kh^{i_0,j_{\min}(L)}(L) \cong \mathbb{Z}$ and $2i_0 - j_{\min}(L) = \delta_{\min}(L) + 2$.*
- (2) *If L is B -Turaev genus one, B -almost alternating, or B -adequate, then there is an $i_0 \in \mathbb{Z}$ such that $Kh^{*,j_{\max}(L)}(L) = Kh^{i_0,j_{\max}(L)}(L) \cong \mathbb{Z}$ and $2i_0 - j_{\max}(L) = \delta_{\max}(L) - 2$.*

Despite the fact that every almost alternating link has Turaev genus one, we chose to include almost alternating links in the statement of the theorem due to their prominence in the proof. Theorem 1.3 is proven separately for A - or B -adequate and almost alternating links. Then Kim's result [Kim18] that says an inadequate Turaev genus one link is almost alternating implies the result for Turaev genus one links. Khovanov [Kho03] proved that the extremal Khovanov homology of an A - or B -adequate link is isomorphic to \mathbb{Z} . Our contribution in Theorem 1.3 for an A - or B -adequate link is to specify the δ -grading of the extremal summand.

The proof of Theorem 1.3 for almost alternating links is quite different than the proof of its Jones polynomial analogue in [DL18]. Resolving the dealternator in an almost alternating diagram D as

either an A -resolution or a B -resolution results in alternating diagrams D_A and D_B respectively. The proof in [DL18] combines formulas for the first few coefficients of the Jones polynomial of the D_A and D_B to prove that either the first or last coefficient of the Jones polynomial of D has absolute value one. We initially hoped to use a similar strategy to prove Theorem 1.3. Since D_A and D_B are alternating links, their Khovanov homology groups $Kh(D_A)$ and $Kh(D_B)$ are well-understood, and the long exact sequence (see Theorem 2.2) relates $Kh(D_A)$, $Kh(D_B)$, and $Kh(D)$. However, in order to compute $Kh(D)$ in its extremal quantum gradings, one would need not only to know the Khovanov homology of D_A and D_B , but also know explicit generators for each homology class in the first and last two quantum gradings of $Kh(D_A)$ and $Kh(D_B)$. Instead we take an inductive approach by resolving crossings in the alternating tangle R , resulting in almost alternating diagrams with fewer crossings than D . See Theorem 4.4 for the details of this result.

Theorem 1.3 has the following corollary.

Corollary 1.4. *If L is a non-split Turaev genus one link, then its Khovanov homology is isomorphic to \mathbb{Z} in at least one of its extremal quantum gradings.*

The study of extremal or near extremal Jones coefficients and Khovanov groups has received considerable attention. Bae and Morton [BM03] developed an algorithm for computing the extremal Jones coefficients from the all- A and all- B states. González-Meneses and Manchón [GMM11] used Bae and Morton's work to prove that there are prime links with arbitrary extremal Jones coefficients. González-Meneses, Manchón, and Silvero [GMMS18] gave a geometric description of the extremal Khovanov homology in terms of the all- A and all- B states. Przytycki and Silvero [PS18a, PS18b] and Morán and Silvero [MS18] further study extremal or near extremal Khovanov groups from various different perspectives.

Often, a result involving a knot polynomial can be strengthened in the homological setting. For example, Lickorish and Thistlethwaite [LT88] proved that the first and last coefficients of the Jones polynomial of an adequate link have absolute value one, while Khovanov [Kho03] proved that such links have extremal Khovanov homology isomorphic to \mathbb{Z} . The span of the Jones polynomial gives a lower bound on the crossing number of a link [Kau87, Mur87, Thi87], and using essentially the same proof and basic facts from the construction of Khovanov homology [Kho00], one can show that the span of the quantum grading of the Khovanov homology of a link gives a sometimes better lower bound on the crossing number. For example, the Jones polynomial lower bound for the crossing number of the knot 10_{132} implies that its crossing number is at least 5. However since the Khovanov homology of 10_{132} in its maximal quantum grading is isomorphic to $\mathbb{Z} \oplus \mathbb{Z}$ and the two \mathbb{Z} -summands cancel in the Euler characteristic, the Khovanov homology lower bound for the crossing number of the knot 10_{132} implies that its crossing number is at least 6. Theorem 1.3 is another example of such a result. In addition to knowing that at least one extremal Khovanov homology group of a Turaev genus one link is isomorphic to \mathbb{Z} , Theorem 1.3 also gives us information about in which diagonal grading that \mathbb{Z} -summand is supported. Example 5.1 gives a knot whose Jones polynomial has leading and trailing coefficient of absolute value one, but both of whose extremal Khovanov homology groups have rank two. Examples 5.2 and 5.3 give knots and links that have one extremal Khovanov group isomorphic to \mathbb{Z} , but that summand is supported in a different diagonal grading than the one specified in Theorem 1.3. Therefore, each of these examples is inadequate, is not almost alternating, and has Turaev genus at least two.

Theorem 1.3 suggests potential relationships between A -/ B -adequate links, almost alternating links, and Turaev genus one links. Any link L that is almost alternating, Turaev genus one, or A - or B -adequate satisfies the following.

- (1) The leading or trailing coefficient of the Jones polynomial of L has absolute value one [LT88, DL18].
- (2) Either the first two or last two coefficients of the Jones polynomial of L alternate in sign [Sto11, LS17].
- (3) The Jones polynomial of L is equal to the Jones polynomial of a trivial m -component link if and only if L is the trivial m -component link for $m \geq 1$ [Sto11, LS17].

The similarities above make it difficult to use invariants to distinguish between these three classes of links. One can show that every almost alternating link is Turaev genus one, and that there are A -adequate (and B -adequate) links that are neither Turaev genus one nor almost alternating (e.g. the $(3, 7)$ -torus knot). We ask the following open questions about almost alternating, Turaev genus one, and A -/ B -adequate links. The authors suspect an affirmative answer to both questions.

Question 1.5. *Does there exist a link of Turaev genus one that is not almost alternating?*

Question 1.6. *Does there exist an almost alternating inadequate link?*

Odd Khovanov homology is a categorification of the Jones polynomial introduced by Ozsváth, Rasmussen, and Szabó [ORS13]. It coincides with Khovanov homology with mod 2 coefficients, but is, in general, different. Theorem 4.6 is a version of Theorem 1.3 for odd Khovanov homology.

1.3. Applications: signature and maximal Thurston Bennequin number. Let $\sigma(L)$ be the signature of the link L , with the convention that the signature of positive trefoil is -2 . We prove that a version of Theorem 1.3 involving signature holds for links that are both A -Turaev genus one and B -Turaev genus one. In Section 6, we conjecture a strengthening of this result.

Theorem 1.7. *Suppose L is a non-split link that is both A -Turaev genus one and B -Turaev genus one. At least one of the following statements hold.*

- (1) *There is an $i_0 \in \mathbb{Z}$ such that $Kh^{*,j_{\min}(L)}(L) = Kh^{i_0(L),j_{\min}(L)}(L) \cong \mathbb{Z}$ and $2i_0(L) - j_{\min}(L) = \sigma(L) + 1$.*
- (2) *There is an $i_0 \in \mathbb{Z}$ such that $Kh^{*,j_{\max}(L)}(L) = Kh^{i_0(L),j_{\max}(L)}(L) \cong \mathbb{Z}$ and $2i_0(L) - j_{\max}(L) = \sigma(L) - 1$.*

The Thurston Bennequin number $\text{tb}(\mathcal{L})$ of an oriented Legendrian link \mathcal{L} measures the framing of the contact plane field around \mathcal{L} . Among all Legendrian links with a given topological link type L , the Thurston Bennequin number $\text{tb}(\mathcal{L})$ is bounded from above. For a topological link L , its *maximal Thurston Bennequin number* $\overline{\text{tb}}(L)$ is defined to be the maximum of $\text{tb}(\mathcal{L})$ over all Legendrian links \mathcal{L} whose topological link type is L . Ng [Ng05] proved that the Khovanov homology gives an upper bound on the maximal Thurston Bennequin number of a link and used that bound to compute $\overline{\text{tb}}(L)$ for any non-split alternating link L . We generalize Ng's approach to Turaev genus one links.

Theorem 1.8. *Let L be a Turaev genus one link with diagram D . Let $w(D)$ be the writhe of D , and let $s_A(D)$ and $s_B(D)$ be the number of components in the all- A and all- B Kauffman states of D respectively.*

- *If D is A -Turaev genus one, then*

$$w(D) - s_A(D) \leq \overline{\text{tb}}(L) \leq w(D) - s_A(D) + 1.$$

- *If D is B -Turaev genus one and \overline{L} is the mirror of L , then*

$$-w(D) - s_B(D) \leq \overline{\text{tb}}(\overline{L}) \leq -w(D) - s_B(D) + 1.$$

This paper is organized as follows. In Section 2, we review the construction of Khovanov homology. In Section 3, we give background information on Turaev genus one and almost alternating links. We also prove that every almost alternating link is A -almost alternating or B -almost alternating and thus that every Turaev genus one link is A -Turaev genus one or B -Turaev genus one. In Section 4, we prove Theorem 1.3. In Section 5, we give examples of knots and links such that Theorem 1.3 implies they are inadequate, not Turaev genus one, and not almost alternating. In Section 6, we prove Theorem 1.7 and discuss progress on a related conjecture. Finally, in Section 7, we recall some facts about Thurston Bennequin numbers and prove Theorem 1.8.

2. KHOVANOV HOMOLOGY BACKGROUND

In this section, we briefly review the construction of Khovanov homology and a few Khovanov homology results relevant to the current paper. For a more detailed account, the reader can refer to one of [Kho00, BN02, Vir04, Kau12, Tur16]. An expert reader may wish to skim the remainder of this section.

The version of the Jones polynomial that Khovanov homology categorifies is defined by the following rules:

- (1) $\langle \diagdown \diagup \rangle = \langle \rangle \langle \rangle - q \langle \diagup \diagdown \rangle$,
- (2) $\langle D \sqcup \bigcirc \rangle = (q + q^{-1}) \langle D \rangle$,
- (3) $\langle \bigcirc \rangle = q + q^{-1}$,
- (4) $V_L(q) = (-1)^{c_-(D)} q^{c_+(D) - 2c_-(D)} \langle D \rangle$,

where $c_+(D)$ is the number of positive ($\diagdown \diagup$) crossings in D and $c_-(D)$ is the number of negative ($\diagup \diagdown$) crossings in D . If we let $\tilde{V}_L(t)$ be the version of the Jones polynomial in [Kau87], then $V_L(q) = (q + q^{-1}) \tilde{V}_L(q^2)$. See [Kau12] for more discussion on the relationship between these two normalizations of the Jones polynomial.

Let $\mathcal{S}(D)$ be the set of Kauffman states of D , and let $s \in \mathcal{S}(D)$ be a Kauffman state. Define $a(s)$ and $b(s)$ to be the number of A -resolutions and the number of B -resolutions respectively in s , and define $|s|$ to be the number of components in s . The Kauffman bracket of D can be represented by the state sum formula

$$\langle D \rangle = \sum_{s \in \mathcal{S}(D)} (-q)^{b(s)} (q + q^{-1})^{|s|}.$$

An *enhanced state* S of D is a Kauffman state s where each component is labeled either 1 or x . Let $\mathcal{S}_{\text{en}}(D)$ be the set of enhanced states of D . Define $a(S)$, $b(S)$, and $|S|$ to be $a(s)$, $b(s)$, and $|s|$ respectively where s is the underlying Kauffman state of the enhanced state S . Furthermore, define $\theta(S)$ to be the difference between the number of 1 labels and the number of x labels on the enhanced state S . Then the Kauffman bracket of D can be represented as the sum of monomials

$$\langle D \rangle = \sum_{S \in \mathcal{S}_{\text{en}}(D)} (-1)^{b(S)} q^{b(S) + \theta(S)}.$$

In order to construct Khovanov homology, we first construct a categorification $\underline{Kh}(D)$ of $\langle D \rangle$ (which is not a link invariant). Then we shift gradings to obtain the link invariant known as Khovanov homology and equivalently denoted as $Kh(L)$ or $Kh(D)$.

The homological grading $i(S)$ of the enhanced state S is defined to be $i(S) = b(S)$, and the quantum grading $j(S)$ of S is defined to be $j(S) = b(S) + \theta(S)$. Let R be a commutative ring with identity, and let $CKh^{i,j}(D; R)$ be the free R -module with basis the enhanced states S with homological grading i and quantum grading j . Define $CKh(D; R) = \bigoplus_{i,j \in \mathbb{Z}} CKh^{i,j}(D; R)$. The ring R will most frequently be the integers \mathbb{Z} , and in that case, we drop R from the notation. For

the sake of notational brevity, we describe the construction of Khovanov homology over \mathbb{Z} , but \mathbb{Z} could be replaced with R throughout to give $Kh(D; R)$ and $\underline{Kh}(D; R)$, Khovanov homology and unshifted Khovanov homology with coefficients in the ring R .

The differential in this complex is a map $d^{i,j} : CKh^{i,j}(D) \rightarrow CKh^{i+1,j}(D)$, i.e. it is a \mathbb{Z} -module map that increases the homological grading by one and preserves the quantum grading. The map d^i is defined on enhanced states and then extended linearly. For any two enhanced states S_0 and S_1 with underlying Kauffman states s_0 and s_1 respectively, we define the *incidence number* $\delta(S_0, S_1)$ as follows. Unless s_1 can be obtained from s_0 by changing a single resolution from an A -resolution to a B -resolution, then we define $\delta(S_0, S_1) = 0$. Suppose that s_1 can be obtained from s_0 by changing a single A -resolution to a B -resolution. Then s_1 can be obtained from s_0 by either merging two components into one or by splitting one component into two. Call all other components of s_0 and s_1 constant components. Unless all labels on the constant components of s_0 are the same as they are in s_1 , then $\delta(S_0, S_1) = 0$. The cases where $\delta(S_0, S_1) = 1$ are illustrated in Figure 2 and described in the next two paragraphs.

Suppose that s_1 can be obtained from s_0 by merging two components into one, and that all constant components are labeled the same in S_0 and S_1 . If the two non-constant components in S_0 are both labeled 1 and the non-constant component in S_1 is labeled 1, then $\delta(S_0, S_1) = 1$. If one of the non-constant components in S_0 is labeled 1 and the other is labeled x and the non-constant component in S_1 is labeled x , then $\delta(S_0, S_1) = 1$. If both of the non-constant components in S_0 are labeled x , then $\delta(S_0, S_1) = 0$.

Suppose that s_1 can be obtained from s_0 by splitting one component into two, and that all constant components are labeled the same in S_0 and S_1 . If the non-constant component in S_0 is labeled 1, one of the non-constant components in S_1 is labeled 1, and the other non-constant component in S_1 is labeled x , then $\delta(S_0, S_1) = 1$. If the non-constant component in S_0 is labeled x and both non-constant components in S_1 are labeled x , then $\delta(S_0, S_1) = 1$.

The last ingredient to define the differential is to assign signs to certain pairs of enhanced states. Arbitrarily number the crossings of D from 1 to $c = c(D)$. Suppose that S_0 and S_1 are enhanced states with underlying Kauffman states s_0 and s_1 such that

- (1) s_1 can be obtained from s_0 by changing a single A -resolution to a B -resolution at crossing k for some k where $1 \leq k \leq c$, and
- (2) the number of B -resolutions in s_0 associated to crossings with labels strictly less than k is odd.

Then define $\varepsilon(S_0, S_1) = -1$. In all other cases, define $\varepsilon(S_0, S_1) = 1$.

The differential $d^{i,j} : CKh^{i,j}(D) \rightarrow CKh^{i+1,j}(D)$ is defined by

$$d^{i,j}(S_0) = \sum_{\substack{S_1 \in \mathcal{S}_{\text{en}}(D) \\ i(S_1) = i(S_0) + 1 \\ j(S_1) = j(S_0)}} \varepsilon(S_0, S_1) \delta(S_0, S_1) S_1.$$

In other words, in the differential of S_0 , we sum over all enhanced states S_1 with the same quantum grading and whose homological grading is one greater than that of S_0 . The term S_1 appears with nonzero coefficient if and only if the incidence number $\delta(S_0, S_1) \neq 0$. The coefficient of the term is ± 1 as determined by the sign $\varepsilon(S_0, S_1)$.

It can be checked that $d^{i+1,j} \circ d^{i,j} : CKh^{i,j}(D) \rightarrow CKh^{i+2,j}(D)$ is the zero map. Thus for each j we have a chain complex. Define the *unshifted Khovanov homology* of D to be the homology

$$\underline{Kh}^{i,j}(D) = \ker d^{i,j} / \text{im } d^{i-1,j}.$$

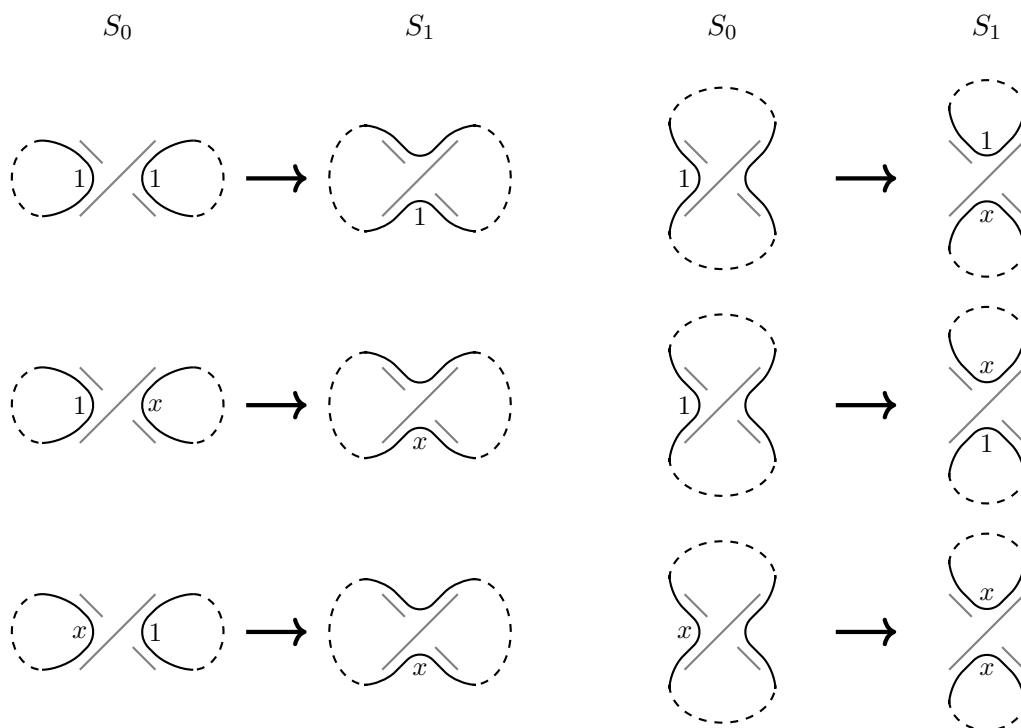

Figure 2: Pairs of enhanced states (S_0, S_1) such that the incidence number $\delta(S_0, S_1) = 1$. The dashed arcs indicate how the arcs of the Kauffman state are connected globally.

Suppose that D is a diagram of the link L such that D has $c_+ = c_+(D)$ positive crossings and $c_- = c_-(D)$ negative crossings. The Khovanov homology of L , denoted equivalently as $Kh(L)$ or $Kh(D)$, is defined by $Kh(L) = \bigoplus_{i,j \in \mathbb{Z}} Kh^{i,j}(L)$ where

$$(2.1) \quad Kh^{i,j}(L) = \underline{Kh}^{i+c_-, j-c_++2c_-}(D).$$

Although unshifted Khovanov homology $\underline{Kh}(D)$ is not a link invariant, it will be useful to describe how it changes under diagrammatic moves that preserve the link type, specifically, under the Reidemeister moves and under flyping. A *flype* is the move on a 2-tangle R depicted in Figure 3.

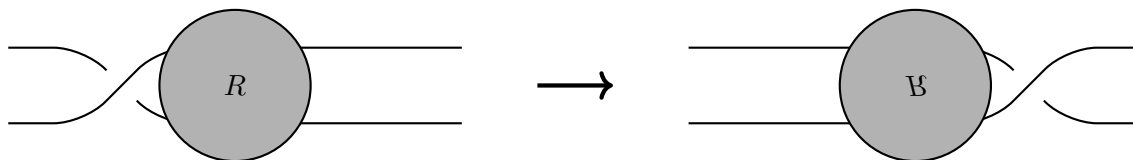

Figure 3: A flype of the tangle R .

Describing how $\underline{Kh}(D)$ changes amounts to computing the change in the number of positive and negative crossings caused by the diagrammatic move. Equation 2.1 implies the following proposition.

Proposition 2.1. *Reidemeister moves and flypes change $\underline{Kh}(D)$ in the following ways.*

- *Positive Reidemeister 1: $\underline{Kh}^{i,j} \left(\begin{array}{c} | \\ | \end{array} \right) \cong \underline{Kh}^{i,j-1} \left(\begin{array}{c} \curvearrowright \\ | \end{array} \right)$.*
- *Negative Reidemeister 1: $\underline{Kh}^{i,j} \left(\begin{array}{c} | \\ | \end{array} \right) \cong \underline{Kh}^{i+1,j+2} \left(\begin{array}{c} \curvearrowleft \\ | \end{array} \right)$.*
- *Reidemeister 2: $\underline{Kh}^{i,j} \left(\begin{array}{c} | \\ | \\ | \end{array} \right) \cong \underline{Kh}^{i+1,j+1} \left(\begin{array}{c} \curvearrowright \\ \curvearrowleft \\ | \end{array} \right)$.*
- *A flype or a Reidemeister move of type 3 does not change the unshifted Khovanov homology $\underline{Kh}(D)$.*

Let D be a link diagram with $c = c(D)$ crossings, and let \bar{D} be the mirror of D . The Khovanov complex $CKh(\bar{D})$ is the dual of the complex $CKh(D)$. Consequently, the following isomorphisms hold:

$$(2.2) \quad \begin{aligned} \underline{Kh}^{i,j}(\bar{D}; \mathbb{Q}) &\cong \underline{Kh}^{c-i, c-j}(D; \mathbb{Q}) \text{ and} \\ \text{Tor } \underline{Kh}^{i,j}(\bar{D}) &\cong \text{Tor } \underline{Kh}^{c-i+1, c-j}(D). \end{aligned}$$

For some crossing X of D , let D_A and D_B represent the diagrams obtained by choosing an A -resolution and a B -resolution at the crossing X respectively and not changing any of the other crossings. There is a natural bijection between the enhanced states of D and the disjoint union of the enhanced states of D_A and D_B : $\mathcal{S}_{\text{en}}(D) \xrightarrow{1:1} \mathcal{S}_{\text{en}}(D_A) \sqcup \mathcal{S}_{\text{en}}(D_B)$. Define $f : CKh(D_B) \rightarrow CKh(D)$ by $f(S) = S$ and extending linearly, where the first S is an enhanced state considered as an element of $\mathcal{S}_{\text{en}}(D_B)$ and the second S is considered as an element of $\mathcal{S}_{\text{en}}(D)$. The map f increases both homological and quantum gradings by one, i.e. it is a map $f : CKh^{i-1, j-1}(D_B) \rightarrow CKh^{i, j}(D)$ for each i and j . Define the map $g : CKh(D) \rightarrow CKh(D_A)$ by

$$g(S) = \begin{cases} 0 & \text{if } S \text{ has a } B\text{-resolution at crossing } X, \\ S & \text{if } S \text{ has an } A\text{-resolution at crossing } X, \end{cases}$$

and extending linearly. The map g preserves both homological and quantum gradings, i.e. it is a map $g : CKh^{i, j}(D) \rightarrow CKh^{i, j}(D_A)$. Both of the maps f and g are chain complex maps, that is both f and g commute with the differential. Also, f is an injection, and g is a surjection. Since $\ker g = \text{im } f$, we have a short exact sequence of complexes

$$0 \rightarrow CKh(D_B) \xrightarrow{f} CKh(D) \xrightarrow{g} CKh(D_A) \rightarrow 0.$$

The long exact sequence in homology associated to this short exact sequence of complexes is given in the following theorem of Khovanov [Kho00].

Theorem 2.2 (Khovanov). *Let D be a link diagram, and let D_A and D_B be the A -resolution and B -resolution respectively of D at a chosen crossing. For each j , there is a long exact sequence of unshifted Khovanov homology*

$$\dots \rightarrow \underline{Kh}^{i-1, j-1}(D_B) \xrightarrow{f_*} \underline{Kh}^{i, j}(D) \xrightarrow{g_*} \underline{Kh}^{i, j}(D_A) \xrightarrow{\partial} \underline{Kh}^{i, j-1}(D_B) \rightarrow \dots$$

where ∂ is the boundary map in the snake lemma.

In other treatments of Khovanov homology, one typically sees two long exact sequences in homology: one for a positive crossing and one for a negative crossing. When working with unshifted Khovanov homology, there is only the single long exact sequence above. The long exact sequence above is at the center of most of the Khovanov homology computations in this paper.

Lee [Lee02] used the long exact sequence in Theorem 2.2 to prove that the Khovanov homology of a non-split alternating links is supported on two diagonals. Lee [Lee05] also defined a map $d_L : CKh^{i,j}(D; \mathbb{Q}) \rightarrow CKh^{i+1,j+4}(D; \mathbb{Q})$ on the Khovanov complex with rational coefficients that anti-commutes with the Khovanov differential. The differential $d + d_L$ is non-decreasing with respect to the quantum grading and so one can define a filtration on the complex $CKh(D; \mathbb{Q})$ with differential $d + d_L$. Rasmussen [Ras10] proved that this gives rise to a spectral sequence whose E_2 term is $Kh(L; \mathbb{Q})$ and that converges to $\mathbb{Q}^{2\ell}$ where L is an ℓ -component link. An analysis of gradings yields the following theorem.

Theorem 2.3 (Lee, Rasmussen). *Suppose that $\text{rank } Kh^{i,j}(L) > 0$. Then $\text{rank } Kh^{p,q}(L) > 0$ where $(p, q) = (i, j + 2), (i, j - 2), (i + 1, j + 4k)$, or $(i - 1, j - 4k)$ for some positive integer k .*

Theorem 2.3 also applies to unshifted Khovanov homology $Kh(D)$.

Recall that a link diagram D is A -adequate if no two arcs in the A -resolution of any crossing lie on the same component of the all- A state of D . Similarly a link diagram is B -adequate if no two arcs in the B -resolution of any crossing lie on the same component of the all- B state. A reduced alternating diagram is both A -adequate and B -adequate. Define $j_{\min}(D)$ to be the minimum quantum grading where $Kh^{*,j}(D)$ is nontrivial. Khovanov [Kho03] proves the following theorem. We recall its proof since it is short and plays an important role in several later proofs.

Theorem 2.4 (Khovanov). *Let D be a link diagram, and let $s_A(D)$ and $s_B(D)$ be the number of components in the all- A and all- B resolutions of D respectively.*

(1) *If D is A -adequate, then $j_{\min}(D) = -s_A(D)$ and*

$$\underline{Kh}^{*, -s_A(D)}(D) = \underline{Kh}^{0, -s_A(D)}(D) \cong \mathbb{Z}.$$

(2) *If D is B -adequate, then $j_{\max}(D) = c(D) + s_B(D)$ and*

$$\underline{Kh}^{*, c(D)+s_B(D)}(D) = \underline{Kh}^{c(D), c(D)+s_B(D)}(D) \cong \mathbb{Z}.$$

Proof. Suppose that s_0 and s_1 are Kauffman states of an arbitrary diagram D' such that s_1 can be obtained from s_0 by changing one A -resolution into a B -resolution. Then $|s_1| = |s_0| \pm 1$. The minimum quantum grading associated to an enhanced state S_0 with underlying Kauffman state either s_0 is $j(S_0) = b(s_0) - |s_0|$, and likewise, the minimum for an enhanced state S_1 with underlying state s_1 is $j(S_1) = b(s_1) - |s_1| = b(s_0) + 1 - |s_1|$.

Since D is A -adequate, each Kauffman state with exactly one B -resolution has $s_A(D) - 1$ components. Thus, the only enhanced state with quantum grading $-s_A(D)$ is the all- A state with each component labeled with an x . Furthermore, there is no enhanced state with quantum grading less than $-s_A(D)$. Thus $j_{\min}(D) = -s_A(D)$. Since there is only one state in quantum grading $-s_A(D)$ and that state is in homological grading 0, it follows that $\underline{Kh}^{*, -s_A(D)}(D) = \underline{Kh}^{0, -s_A(D)}(D) \cong \mathbb{Z}$. Statement (2) of the theorem is implied by statement (1) and Equation 2.2. \square

3. TURAEV GENUS ONE AND ALMOST ALTERNATING LINKS

In this section, we construct the Turaev surface, discuss results about the Turaev genus of a link (especially Turaev genus one links), and explore the connection between Turaev genus one and almost alternating links. Finally, we prove that every almost alternating link is A -almost

alternating or B -almost alternating, and consequently, every Turaev genus one link is A -Turaev genus one or B -Turaev genus one.

3.1. Definitions and lower bounds. The Turaev surface of a link diagram D is constructed as follows. Consider D to be embedded on a sphere S^2 sitting inside of S^3 . Embed the all- A and all- B states of D in a neighborhood of S^2 but on opposite sides in S^3 . Construct a cobordism between the all- A and all- B states that has saddles near the crossings of D (see Figure 4) and consists of bands away from the crossings. The intersection of the cobordism with the sphere S^2 is precisely the diagram D . Capping off each boundary component of the cobordism with a disk forms the *Turaev surface* of D .

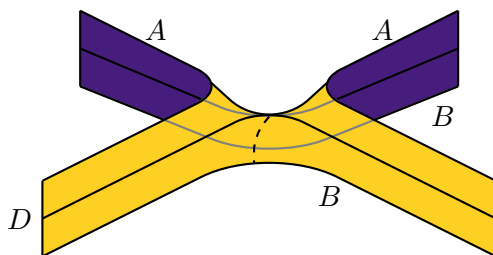

Figure 4: A saddle transitions between the all- A and all- B states in a neighborhood of each crossing of D .

If D is a connected link diagram with $c(D)$ crossings whose all- A state has $s_A(D)$ components and whose all- B state has $s_B(D)$ components, then the genus $g_T(D)$ of the Turaev surface is given by

$$(3.1) \quad g_T(D) = \frac{1}{2} (2 + c(D) - s_A(D) - s_B(D)).$$

Define the *Turaev genus* $g_T(L)$ of the non-split link L to be

$$g_T(L) = \min\{g_T(D) \mid D \text{ is a diagram of } L\}.$$

Turaev [Tur87] showed that the Turaev surface of a link diagram D is a sphere if and only if D is the connected sum of alternating diagrams. Consequently, the Turaev genus of a link is zero if and only if it is alternating. Turaev also showed that the span of the Jones polynomial gives a lower bound for the difference between the crossing number and the Turaev genus of L

$$\text{span } \tilde{V}_L(t) \leq c(L) - g_T(L).$$

Thistlethwaite [Thi87] proved that the Jones polynomial of an alternating link L is an evaluation of the Tutte polynomial of the checkerboard graph of an alternating diagram of L . Dasbach, Futer, Kalfagianni, Lin, and Stoltzfus [DFK⁺08] extended this result by showing that the Jones polynomial of an arbitrary link is the evaluation of the Bollobás-Riordan-Tutte polynomial of a certain graph embedded in the Turaev surface. Dasbach and Lowrance [DL14] further extended this work by giving a Turaev surface model for Khovanov homology. Dasbach, Futer, Kalfagianni, Lin, and Stoltzfus [DFK⁺10] gave a formula for the determinant coming from the Turaev surface. This formula says that the determinant of a link of Turaev genus one is the difference between the number of spanning trees in two graphs dually embedded on the Turaev surface. See the recent survey [CK14] and chapter [KK18] for more details.

Recall that a link diagram D is almost alternating if one crossing change can transform D into an alternating diagram, and that a link L is almost alternating if it is non-alternating and has an almost alternating diagram. Almost alternating knots and links share many, but certainly not all, of the nice properties of alternating links.

If D is almost alternating, then $s_A(D) + s_B(D) = c(D)$, and thus $g_T(D) = 1$. Therefore every almost alternating link is Turaev genus one. Define the *dealternating number* $\text{dalt}(D)$ of a link diagram D to be the fewest number of crossings changes necessary to transform D into an alternating diagram, and define the *dealternating number* $\text{dalt}(L)$ of the link L by

$$\text{dalt}(L) = \{\text{dalt}(D) \mid D \text{ is a diagram of } L\}.$$

Alternating links are the class of links with dealternating number zero, and almost alternating links are the class of links with dealternating number one.

Abe and Kishimoto [AK10] proved that for any link L , the Turaev genus of L is less than or equal to the dealternating number of L , i.e. $g_T(L) \leq \text{dalt}(L)$. There are no known algorithms to compute either the Turaev genus or dealternating number of a link. Instead most computations of either invariant come from various lower bounds. Asaeda and Przytycki [AP04] proved that the Khovanov homology of an almost alternating link is supported on at most three adjacent diagonals, and more generally that the Khovanov homology of a link is supported on at most $\text{dalt}(L) + 2$ adjacent diagonals. Manturov [Man06] and Champanerkar, Kofman, and Stoltzfus [CKS07] proved a similar result using the Turaev genus of a link in place of the dealternating number, showing that the Khovanov homology of a link is supported on at most $g_T(L) + 2$ adjacent diagonals. Dasbach and Lowrance [DL11] refined these results to express the diagonal gradings of Khovanov homology where the link is supported in terms of the number of components of the all- A and all- B states.

Theorem 3.1 (Dasbach, Lowrance). *Let L be a non-split link with diagram D . If $Kh^{i,j}(L)$ is nontrivial, then $2i - j \equiv s_A(D) - c_+(D) \pmod{2}$ and*

$$s_A(D) - c_+(D) - 2 \leq 2i - j \leq c_-(D) - s_B(D) + 2.$$

If D is a Turaev genus one diagram, then

$$s_A(D) - c_+(D) - 2 \leq 2i - j \leq s_A(D) - c_+(D) + 2.$$

Although it is not explicitly stated, the work of Ozsváth and Szabó in [OS03a] can be used to show that the knot Floer homology of a link L can be supported on at most $\text{dalt}(L) + 1$ adjacent diagonals. Lowrance [Low08] showed that the knot Floer homology of L can be supported on at most $g_T(L) + 1$ adjacent diagonals. These results can now be seen as a consequence of the analogous results for reduced Khovanov homology and the spectral sequence from reduced Khovanov homology to knot Floer homology [Dow18].

Let $\sigma(K)$ be the signature of the knot K , let $s(K)$ be the Rasmussen s -invariant [Ras10], and let $\tau(K)$ be the Ozsváth-Szabó τ -invariant [OS03b]. Abe [Abe09a] proved that the quantities $\frac{1}{2}|s(K) + \sigma(K)|$ and $|\tau(K) + \sigma(K)/2|$ are lower bounds for the Gordian distance between a knot K and the set of alternating knots. Therefore,

$$(3.2) \quad \begin{aligned} \frac{1}{2}|s(K) + \sigma(K)| &\leq \text{dalt}(K) \text{ and} \\ \left| \tau(K) + \frac{\sigma(K)}{2} \right| &\leq \text{dalt}(K). \end{aligned}$$

Dasbach and Lowrance [DL11] showed that for any knot K , both

$$(3.3) \quad \begin{aligned} \frac{1}{2}|s(K) + \sigma(K)| &\leq g_T(K) \text{ and} \\ \left| \tau(K) + \frac{\sigma(K)}{2} \right| &\leq g_T(K). \end{aligned}$$

In a different direction, one can use the Jones polynomial to obstruct being Turaev genus one and almost alternating. Kauffman [Kau87] proved that the both the leading and trailing coefficients of the Jones polynomial of an alternating link have absolute value one. Thistlethwaite [Thi87] proved that the coefficients of the Jones polynomial of a non-split alternating link alternate in sign. Dasbach and Lowrance [DL18] proved that at least one of the leading or trailing coefficients of the Jones polynomial of a Turaev genus one or almost alternating link has absolute value one. Theorem 1.3 can be viewed as a Khovanov homology generalization of this result. Extending this work, Lowrance and Spyropoulos [LS17] proved that at least one of the first two or last two coefficients of the Jones polynomial of a Turaev genus one or almost alternating link alternate in sign and showed that the Jones polynomial of an ℓ -component Turaev genus one or almost alternating link is different than the Jones polynomial of an ℓ -component unlink.

There is no known example of a link L with $g_T(L) < \text{dalt}(L)$. In particular, it is an open question whether every Turaev genus one link is almost alternating. The difficulty in producing such an example is that nearly all of the lower bounds on the dealternating number of a knot or link are also lower bounds on its Turaev genus. For more about distinguishing these two invariants see [Low15] and [Low18].

There is a small but growing number of computations of Turaev genus and dealternating number in the literature. Among knots with 11 or fewer crossings, all but two ($11n_{95}$ and $11n_{118}$) are known to be either alternating or Turaev genus one (and hence alternating or almost alternating) [ABB⁺92, GHY01]. The knot $11n_{95}$ has Turaev genus and dealternating number two [DL18], while the Turaev genus and dealternating numbers of $11n_{118}$ are either one or two. Abe [Abe09a] and Lowrance [Low11] proved that the almost alternating and Turaev genus one torus knots are $T_{3,4}$, $T_{3,5}$, and their mirrors. Abe and Kishimoto [AK10] and Lowrance [Low11] computed the Turaev genus and dealternating numbers of 3-stranded torus links and many closed 3-braids. Abe [Abe09b] proved that any adequate diagram is Turaev genus minimizing. Jin, Lowrance, Polston, and Zheng [JLPZ17] computed the Turaev genus of all 4-stranded torus knots and of many 5-stranded and 6-stranded torus knots.

The definitions of both alternating links and almost alternating links are intrinsically diagrammatic. A link is alternating (or almost alternating) if it has a diagram that satisfies certain properties. Fox famously asked ‘‘What is an alternating knot?’’ [Lic97, p. 32] - where he was asking for a topological characterization of alternating knots. Two such characterizations, one by Greene [Gre17] and one by Howie [How17], recently appeared in the literature. Building on the ideas of Greene and Howie, Ito [Ito18] and Kim [Kim16] gave topological characterizations of almost alternating knots. There is currently no topological characterization of Turaev genus one knots or links.

3.2. A/B -Turaev genus one and A/B -almost alternating. In this section, we prove that every almost alternating link is A -almost alternating or B -almost alternating, and that every Turaev genus one link is either A -Turaev genus one or B -Turaev genus one. Throughout this section we use the notation depicted in Figure 1 for an almost alternating link diagram. The alternating tangle is R and the four regions with the dealternator in their boundary are u_1 , u_2 , v_1 , and v_2 .

Alternating and almost alternating links have almost alternating diagrams. Let D be an almost alternating diagram. If the regions u_1 and u_2 in D are the same region or if the regions v_1 and v_2

in D are the same region, then L is alternating. Similarly, if there is a crossing in R contained in the boundary of regions u_1 and u_2 or if there is a crossing in R contained in the boundary of v_1 and v_2 , then L is again alternating. If L is almost alternating (and hence non-alternating), these configurations cannot exist in D . See Figure 5. Unless otherwise stated, we assume that all almost alternating diagrams in the paper have distinct u_1 and u_2 , distinct v_1 and v_2 , no crossing in R in the boundary of u_1 and u_2 , and no crossing in R in the boundary of v_1 and v_2 .

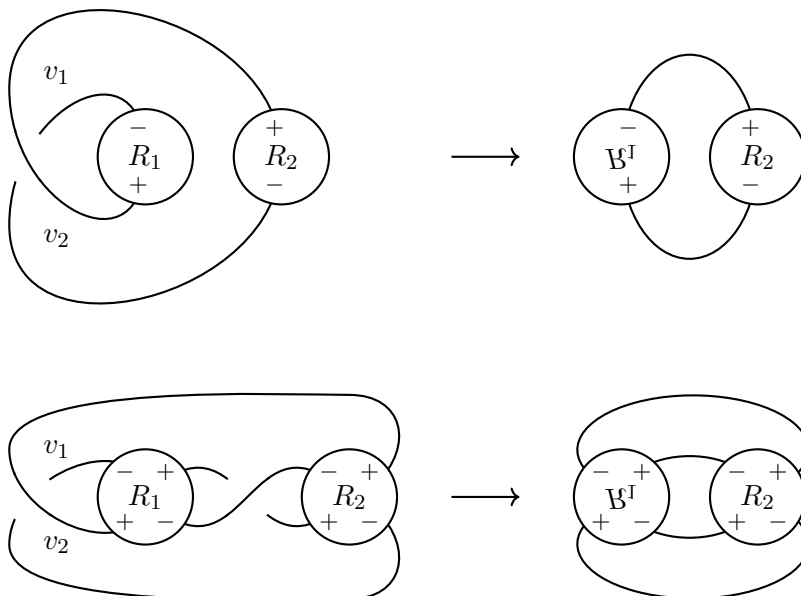

Figure 5: Two almost alternating diagrams of alternating links. On the top, the regions v_1 and v_2 are the same, and removing the nugatory crossing yields an alternating diagram. On the bottom, the regions v_1 and v_2 are incident to the same crossing in the alternating tangle R . A flype followed by a Reidemeister 2 move yields an alternating diagram.

We now set about proving that every almost alternating link is A -almost alternating or B -almost alternating. In order to do so, we introduce the checkerboard graph of the link diagram. Let D be an almost alternating diagram as in Figure 1. We associate two checkerboard graphs G and \overline{G} to D as follows. Color the complementary regions of D in a checkerboard fashion so that the shading at each crossing looks like \times or \times . The shaded regions of D are in one-to-one correspondence with the vertices of G , and the unshaded regions of D are in one-to-one correspondence with the vertices of \overline{G} (or vice versa). The crossings of D are in one-to-one correspondence with the edges of G and with the edges of \overline{G} . Two vertices u and v are incident to an edge e in G (or in \overline{G}) if the regions associated to vertices u and v meet at the crossing associated to e . The graphs G and \overline{G} are planar duals of one another.

By a slight abuse of notation, the vertices associated to the regions meeting at the dealternator are labeled u_1 , u_2 , v_1 , and v_2 as in Figure 1. Define G to be the checkerboard graph of D containing the vertices u_1 and u_2 , and define \overline{G} be the checkerboard graph of D containing the vertices v_1 and v_2 . Let G' and \overline{G}' be the simplifications of G and \overline{G} respectively, that is G' is G with each

sets of multiple edges identified into a single edge, and likewise for \overline{G}' . Define $\text{adj}(u_1, u_2)$ to be the number of paths of length two between u_1 and u_2 in G' , and $\text{adj}(v_1, v_2)$ to be the number of paths of length two between v_1 and v_2 in \overline{G}' . With this definition, an almost alternating diagram of an almost alternating link is A -almost alternating if and only if $\text{adj}(u_1, u_2) = 0$ and is B -almost alternating if and only if $\text{adj}(v_1, v_2) = 0$. In the next few lemmas, we show that if $\text{adj}(u_1, u_2)$ and $\text{adj}(v_1, v_2)$ satisfy certain constraints, then the link is alternating.

Lemma 3.2. *If D is an almost alternating diagram of a link L such that $\text{adj}(u_1, u_2) = 2$ and $\text{adj}(v_1, v_2) = 1$ (or if $\text{adj}(u_1, u_2) = 1$ and $\text{adj}(v_1, v_2) = 2$), then L is alternating.*

Proof. Let D be an almost alternating diagram of L satisfying conditions (1) and (2) in Definition 1.1 and also such that $\text{adj}(u_1, u_2) = 2$ and $\text{adj}(v_1, v_2) = 1$. Let G be the checkerboard graph of D containing u_1 and u_2 . Suppose that the two paths of length two between u_1 and u_2 in G have edge sets $\{e_1, e_2\}$ and $\{e_3, e_4\}$ respectively, where e_1 and e_3 are incident to u_1 and e_2 and e_4 are incident to u_2 .

The path of length two in \overline{G} between v_1 and v_2 contains an edge dual to either e_1 or e_2 and an edge dual to either e_3 or e_4 . If the path contains edges dual to e_1 and e_3 (or dual to e_2 and e_4), then up to symmetry, D has a diagram as in the leftmost picture of Figure 6. If the path contains edges dual to e_1 and e_4 (or dual to e_2 and e_3), then up to symmetry, D has diagram as in the leftmost picture of Figure 7. In both figures, the tangles R_i are alternating tangles. Each figure shows an isotopy between D and an alternating diagram.

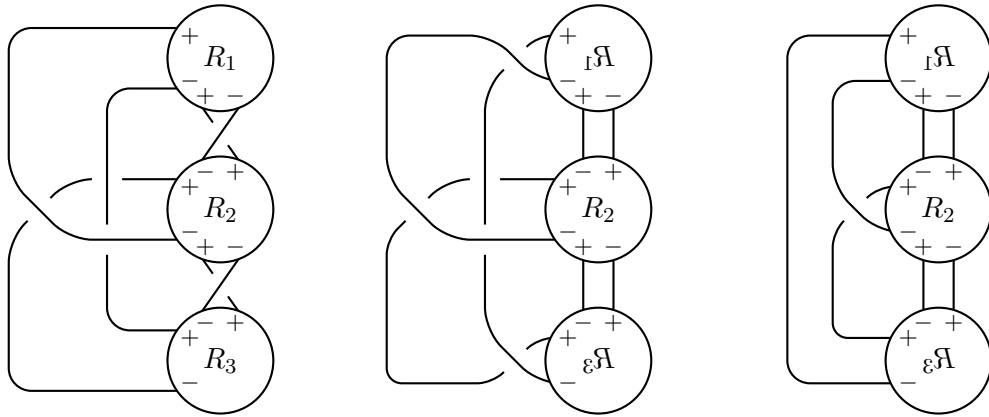

Figure 6: An isotopy between D and an alternating diagram when $\text{adj}(u_1, u_2) = 2$ and $\text{adj}(v_1, v_2) = 1$. To obtain the second diagram from the first, perform two flypes, and to obtain the third diagram from the second perform isotopies of the strands on the left of the tangles.

□

Lemma 3.3. *If D is an almost alternating diagram of a link L such that $\text{adj}(u_1, u_2) = \text{adj}(v_1, v_2) = 2$, then L is the disjoint union of an alternating link and an unknot.*

Proof. Let D be an almost alternating diagram of L satisfying conditions (1) and (2) in Definition 1.1 and also such that $\text{adj}(u_1, u_2) = \text{adj}(v_1, v_2) = 2$. The checkerboard graph G has two paths between u_1 and u_2 , and the checkerboard graph \overline{G} has two paths between v_1 and v_2 . Moreover, the edges in the paths between u_1 and u_2 are dual to the edges in the paths between v_1 and v_2 .

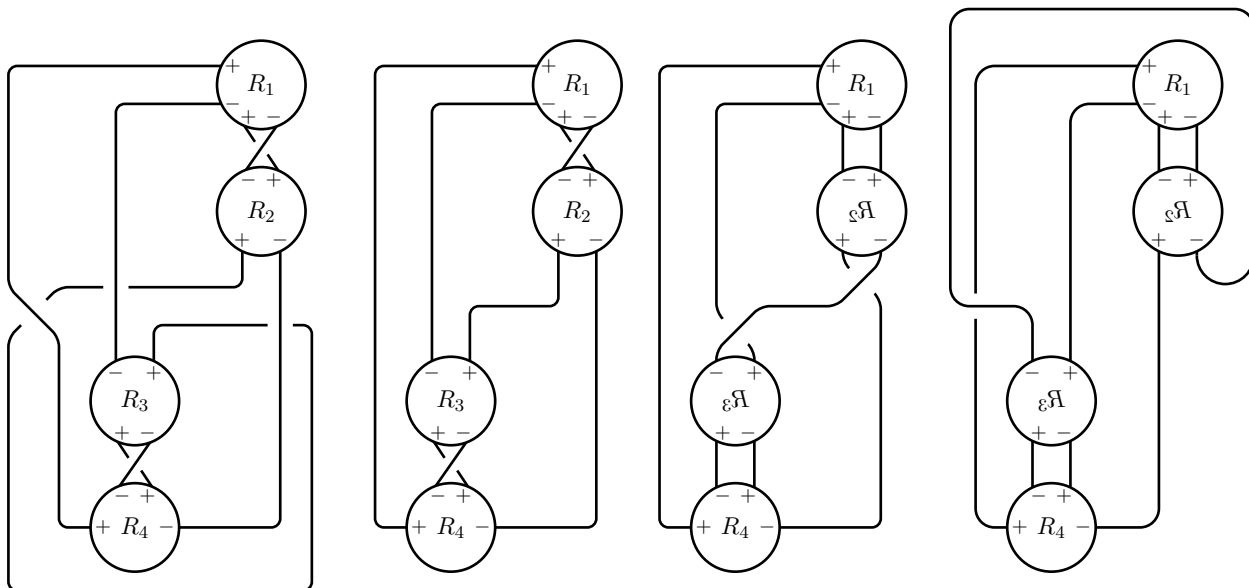

Figure 7: An isotopy between D and an alternating diagram when $\text{adj}(u_1, u_2) = 2$ and $\text{adj}(v_1, v_2) = 1$. In step 1, the strand between R_2 and R_3 is pulled beneath the diagram. In step 2, two flypes are performed, and finally in step 3, the strand between R_2 and R_3 is pulled above the rest of the diagram.

Hence the diagram D is the leftmost picture in Figure 8 where R is an alternating tangle. Figure 8 shows an isotopy between D and the disjoint union of an unknot and an alternating diagram. \square

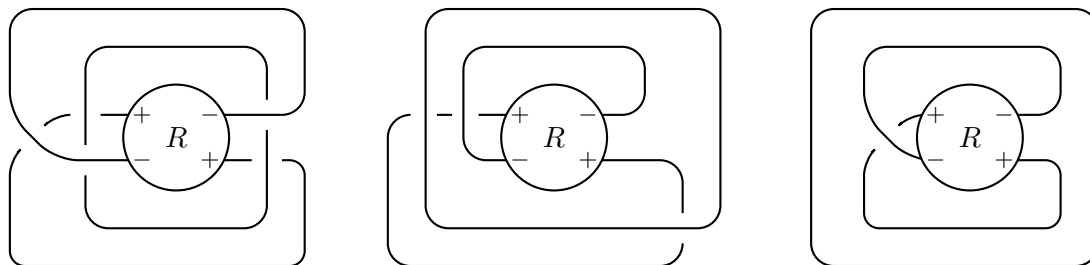

Figure 8: On the left is the almost alternating diagram D when $\text{adj}(u_1, u_2) = \text{adj}(v_1, v_2) = 2$. The isotopy described by the pictures shows that L is the disjoint union of an unknot and an alternating link.

The previous two lemmas combine to give the following theorem.

Theorem 3.4. *Every almost alternating link is A-almost alternating or B-almost alternating.*

Proof. Since G and \bar{G} are dual graphs, if $\text{adj}(u_1, u_2) > 2$, then $\text{adj}(v_1, v_2) = 0$; if $\text{adj}(v_1, v_2) > 2$, then $\text{adj}(u_1, u_2) = 0$. If $\text{adj}(u_1, u_2) = \text{adj}(v_1, v_2) = 1$, then the isotopy in Figure 9 yields an

almost alternating diagram of the link with two fewer crossings (as also shown in [DL18, Theorem 1.3] and [LS17, Theorem 3.3]). Hence the only possibilities remaining where neither $\text{adj}(u_1, u_2)$ or $\text{adj}(v_1, v_2)$ are zero are

- (1) $\text{adj}(u_1, u_2) = 2$ and $\text{adj}(v_1, v_2) = 1$,
- (2) $\text{adj}(u_1, u_2) = 1$ and $\text{adj}(v_1, v_2) = 2$, or
- (3) $\text{adj}(u_1, u_2) = \text{adj}(v_1, v_2) = 2$.

Lemmas 3.2 and 3.3 show that in each of the three above cases, the link is alternating. Thus either $\text{adj}(u_1, u_2) = 0$ or $\text{adj}(v_1, v_2) = 0$, and hence D is A -almost alternating or B -almost alternating. \square

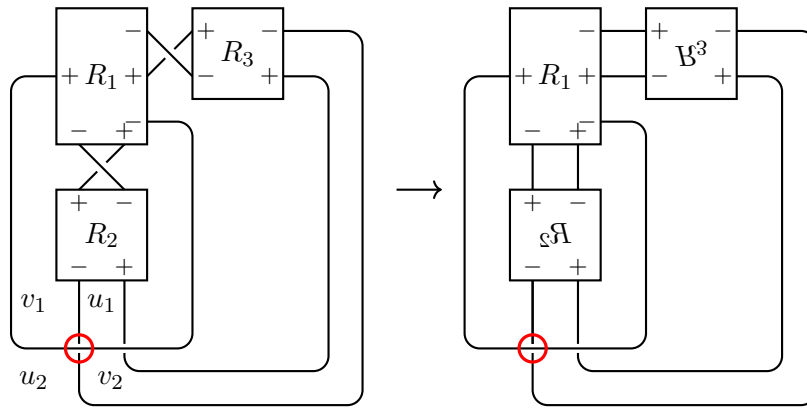

Figure 9: If $\text{adj}(u_1, u_2) = \text{adj}(v_1, v_2) = 1$, then the link has an almost alternating diagram with two fewer crossings.

Armond and Lowrance [AL17] and independently Kim [Kim18] proved that every non-split Turaev genus one link has a diagram as in Figure 10. Each tangle R_i in Figure 10 is an alternating tangle both of whose closures are connected link diagrams. Kim used this classification to prove the following theorem, whose proof we sketch.

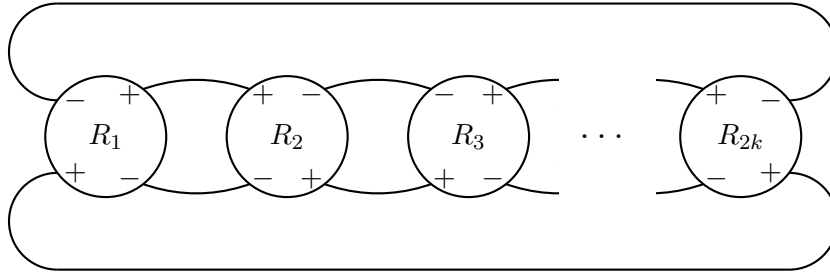

Figure 10: Every non-split link of Turaev genus one has a diagram as above. Each R_i is an alternating tangle whose closures are connected link diagrams.

Theorem 3.5 (Kim). *Every Turaev genus one link has a diagram that is either A -adequate, B -adequate, or almost alternating.*

Sketch of proof. Let D be a Turaev genus one diagram as in Figure 10, and let w_1 and w_2 be the two regions that meet all of the alternating tangles R_i for $i = 1, \dots, 2k$. Kim calls any crossing in the boundary of both w_1 and w_2 an AB -loop crossing because it is precisely these crossing that will lead to the diagram being not A -adequate or not B -adequate. Performing a sequence of flypes can collect all of the AB -loop crossings into one twist region, and performing Reidemeister 2 moves in the twist region can ensure each crossing in the twist region has the same sign.

Upon completing this process, if there are either zero or more than two crossings in the twist region, then the diagram is A -adequate or B -adequate. If there is exactly one crossing in the twist region and the total number of alternating tangles in the decomposition (other than the twist region) is greater than one, then the diagram is again either A -adequate or B -adequate. Finally, if there is exactly one crossing in the twist region and exactly one other alternating tangle in the decomposition, then the diagram looks like Figure 1, and hence is almost alternating. \square

Figure 11 shows the algorithm described in the previous sketch. In the initial diagram, tangles of the form R_i^j combine to make up the tangle R_i from Figure 10. The resulting link diagram has a twist region with two crossing plus four additional alternating tangles, and the final diagram is B -adequate.

Theorems 3.4 and 3.5 combine to give the following corollary.

Corollary 3.6. *Every Turaev genus one link is A -Turaev genus one or B -Turaev genus one.*

4. EXTREMAL KHOVANOV HOMOLOGY

4.1. A - and B -adequate links. Recall that a link diagram D is A -adequate if no two arcs in the A -resolution of any crossing lie on the same component of the all- A state of D . Similarly a link diagram is B -adequate if no two arcs in the B -resolution of any crossing lie on the same component of the all- B state. Links can be partitioned into three sets: adequate, semi-adequate, and inadequate. Adequate links are those links with a diagram that is both A -adequate and B -adequate, semi-adequate links are those links with a diagram that is either A -adequate or B -adequate, but not both, and inadequate links are those links where every diagram is neither A -adequate nor B -adequate.

Lickorish and Thistlethwaite [LT88] introduced adequate and semi-adequate links and studied their Jones polynomials. Thistlethwaite [Thi88] later studied the Kauffman polynomial of adequate links. Semi-adequate links play an important role in hyperbolic geometry (see [FKP15], [FKP14] and references within) and in the study of the colored Jones polynomial (see [Arm13, FKP13, KL14, Kal18]).

The following theorem is a version of Theorem 1.3 for A -adequate or B -adequate links. Khovanov [Kho03] proved that the extremal Khovanov homology of an A -adequate or B -adequate link is isomorphic to \mathbb{Z} (see Theorem 2.4). Our contribution is to determine the diagonal grading where this \mathbb{Z} summand is supported.

Theorem 4.1. *Let L be a non-split link.*

- (1) *If L is A -adequate, then there is an $i_0 \in \mathbb{Z}$ such that*

$$Kh^{*,j_{\min}(L)}(L) = Kh^{i_0(L),j_{\min}(L)}(L) \cong \mathbb{Z}$$

$$\text{and } 2i_0(L) - j_{\min}(L) = \delta_{\min}(L) + 2.$$

- (2) *If L is B -adequate, then there is an $i_0 \in \mathbb{Z}$ such that*

$$Kh^{*,j_{\max}(L)}(L) = Kh^{i_0(L),j_{\max}(L)}(L) \cong \mathbb{Z}$$

$$\text{and } 2i_0(L) - j_{\max}(L) = \delta_{\max}(L) - 2.$$

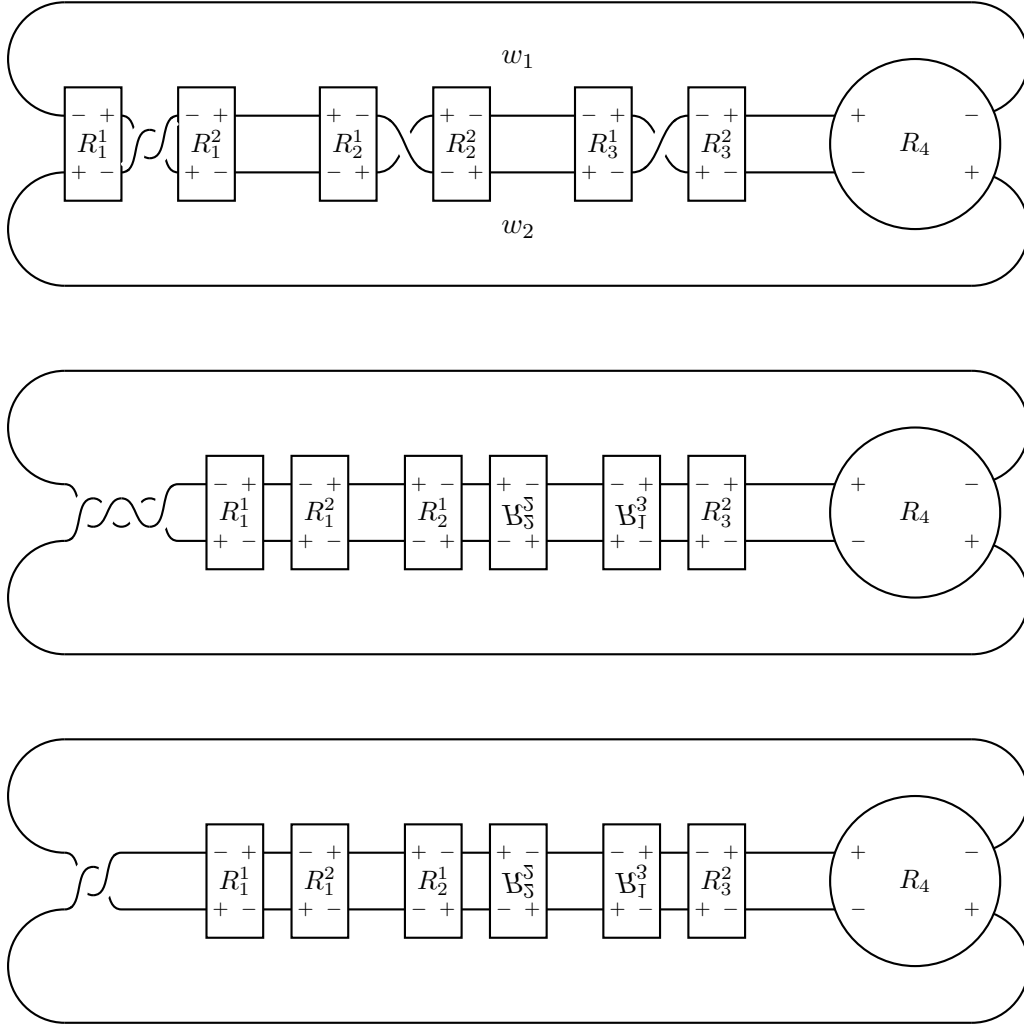

Figure 11: An example of the algorithm described in the proof of Theorem 3.5.

Proof. Suppose that L is an A -adequate link with A -adequate diagram D . Theorem 2.4 and Equation 2.1 imply that $j_{\min}(L) = -s_A(D) + c_+(D) - 2c_-(D)$ and

$$Kh^{*,j_{\min}(L)}(L) = Kh^{-c_-(D),j_{\min}(L)}(L) \cong \mathbb{Z}.$$

Hence the diagonal grading of this summand is

$$2i - j = -2c_-(D) - (-s_A(D) + c_+(D) - 2c_-(D)) = s_A(D) - c_+(D).$$

Theorem 3.1 implies that $s_A(D) - c_+(D) - 2 \leq \delta_{\min}(L)$. Hence Theorem 2.3 and the fact that $j_{\min}(L)$ is the minimum quantum grading imply that $\text{rank } Kh^{p,q}(L) > 0$ for $(p, q) = (-c_-(D), j_{\min}(L) + 2)$ or $(1 - c_-(D), j_{\min}(L) + 4)$. In either case, we conclude that $\delta_{\min}(L) = s_A(D) - c_+(D) - 2$ and that

$$Kh^{*,j_{\min}(L)}(L) = Kh^{i_0(L),j_{\min}(L)}(L) \cong \mathbb{Z}$$

where $2i_0(L) - j_{\min}(L) = \delta_{\min}(L) + 2$. The case where L is B -adequate follows from Equation 2.2. \square

4.2. A - and B -almost alternating links. In this section, we prove Theorem 1.3. Since every Turaev genus one link is A -adequate, B -adequate, A -almost alternating, or B -almost alternating, it remains to show that Theorem 1.3 holds for almost alternating links. First, we compute the quantum grading of the extremal Khovanov group of an A -almost alternating link and show that extremal Khovanov group is isomorphic to \mathbb{Z} . Next we show how the diagonal grading of this summand relates to the minimal and maximal diagonal gradings. We use Equation 2.2 to deduce the analogous result for B -almost alternating links.

Our next goal is to prove that if D is an A -almost alternating diagram, then $j_{\min}(D) = -s_A(D) + 2$ and $\underline{Kh}^{*,j_{\min}(D)}(D) \cong \mathbb{Z}$. Our first task is to show that $\underline{Kh}(D)$ is trivial in quantum gradings below $-s_A(D) + 2$.

Theorem 4.2. *Let D be an A -almost alternating diagram, and let $s_A(D)$ be the number of components in the all- A state of D . If $j < -s_A(D) + 2$, then $\underline{Kh}^{i,j}(D) = 0$ for any $i \in \mathbb{Z}$.*

Proof. If $j < -s_A(D)$, then there are no enhanced states with quantum grading j , and the result follows. Since the quantum gradings of all states of D are equivalent mod 2, it suffices to focus on the case where $j = -s_A(D)$. There are exactly two enhanced states with quantum grading $j = -s_A(D)$. The first of these states S_1 is the all- A Kauffman state enhanced with an x label on each component. The second of these states S_2 is the state where every crossing other than the dealternator is assigned an A -resolution, the dealternator is assigned the B -resolution, and every component is enhanced with an x label. The differential in the Khovanov complex takes S_1 to S_2 and so neither state represents a homology class. Thus $\underline{Kh}^{i,-s_A(D)}(D) = 0$ for all $i \in \mathbb{Z}$. \square

The following lemma is the main technical tool in our extremal Khovanov computations, and it is a consequence of the long exact sequence in Theorem 2.2.

Lemma 4.3. *Let D , D_A , and D_B be link diagrams that are identical outside of a neighborhood of a crossing in D and where that crossing is replaced by an A -resolution in D_A and a B -resolution in D_B . If $j_{\min}(D_A) - 1 < j_{\min}(D_B)$, then $j_{\min}(D) = j_{\min}(D_A)$ and $\underline{Kh}^{i,j_{\min}(D)}(D) \cong \underline{Kh}^{i,j_{\min}(D_A)}(D_A)$ for all $i \in \mathbb{Z}$.*

Proof. Suppose that $j < j_{\min}(D_A)$. Then $j - 1 < j_{\min}(D_A) - 1 < j_{\min}(D_B) - 1$. Therefore $\underline{Kh}^{*,j-1}(D_B)$ and $\underline{Kh}^{*,j}(D_A)$ are trivial, and the long exact sequence of Theorem 2.2 implies that $\underline{Kh}^{*,j}(D)$ is also trivial.

Since $j_{\min}(D_A) - 1 < j_{\min}(D_B)$, it follows that $\underline{Kh}^{*,j_{\min}(D_A)-1}(D_B)$ is trivial. The long exact sequence of Theorem 2.2 becomes

$$0 \rightarrow \underline{Kh}^{i,j_{\min}(D_A)}(D) \rightarrow \underline{Kh}^{i,j_{\min}(D_A)}(D_A) \rightarrow 0$$

for each $i \in \mathbb{Z}$. Therefore $\underline{Kh}^{i,j_{\min}(D)}(D) \cong \underline{Kh}^{i,j_{\min}(D_A)}(D_A)$ for each $i \in \mathbb{Z}$, and the result follows. \square

In the following theorem, we prove that the extremal Khovanov homology of an almost alternating link is isomorphic to \mathbb{Z} .

Theorem 4.4. *Let D be a non-split almost alternating diagram.*

(1) *If D is A -almost alternating, then $j_{\min}(D) = 2 - s_A(D)$ and*

$$\underline{Kh}^{*,j_{\min}(D)}(D) = \underline{Kh}^{1,j_{\min}(D)}(D) \cong \mathbb{Z}.$$

(2) If D is B -almost alternating, then $j_{\max}(D) = s_B(D) - 2$ and

$$\underline{Kh}^{*,j_{\max}(D)}(D) = \underline{Kh}^{c(D)-1,j_{\max}(D)}(D) \cong \mathbb{Z}.$$

Proof. Suppose that D is an A -almost alternating diagram such that the diagram obtained by taking an A -resolution for any crossing in R is not A -almost alternating. Taking an A -resolution corresponds to deleting an edge in G and thus does not increase $\text{adj}(u_1, u_2)$. Therefore, it must be the case the diagram obtained by performing an A -resolution of any crossing in R has a crossing in the boundary of both v_1 and v_2 . Hence D is the diagram in Figure 12. Figure 12 shows that in this case D and D_{alt} are diagrams of the same alternating link. Since D_{alt} is alternating, $j_{\min}(D_{\text{alt}}) = -s_A(D_{\text{alt}}) = -a - b + 4$ and $\underline{Kh}^{*,j_{\min}(D_{\text{alt}})}(D_{\text{alt}}) = \underline{Kh}^{0,-a-b+4}(D_{\text{alt}}) \cong \mathbb{Z}$. Proposition 2.1 then implies that $j_{\min}(D) = -a - b + 1 = -s_A(D) + 2$ and that $\underline{Kh}^{*,j_{\min}(D)}(D) = \underline{Kh}^{1,-s_A(D)+2}(D) \cong \mathbb{Z}$, as desired.

Now suppose that D is an A -almost alternating diagram such that D contains a crossing in R whose A -resolution D_A is also A -almost alternating. By induction, $j_{\min}(D_A) = -s_A(D_A) + 2$ and $\underline{Kh}^{*,j_{\min}(D_A)}(D_A) = \underline{Kh}^{1,-s_A(D_A)+2}(D_A) \cong \mathbb{Z}$. The diagram D_B is almost alternating, and hence Theorem 4.2 implies that $j_{\min}(D_B) \geq -s_A(D_B) + 2$. Since $s_A(D) = s_A(D_A) = s_A(D_B) + 1$, it follows that $j_{\min}(D_A) - 1 = -s_A(D_A) + 1 < -s_A(D_B) + 2 \leq j_{\min}(D_B)$. Thus Lemma 4.3 implies that $j_{\min}(D) = j_{\min}(D_A) = -s_A(D_A) + 2 = -s_A(D) + 2$ and $\underline{Kh}^{*,j_{\min}(D)}(D) = \underline{Kh}^{1,-s_A(D)+2}(D) \cong \mathbb{Z}$.

The case where D is B -almost alternating follows from the A -almost alternating case and Equation 2.2. \square

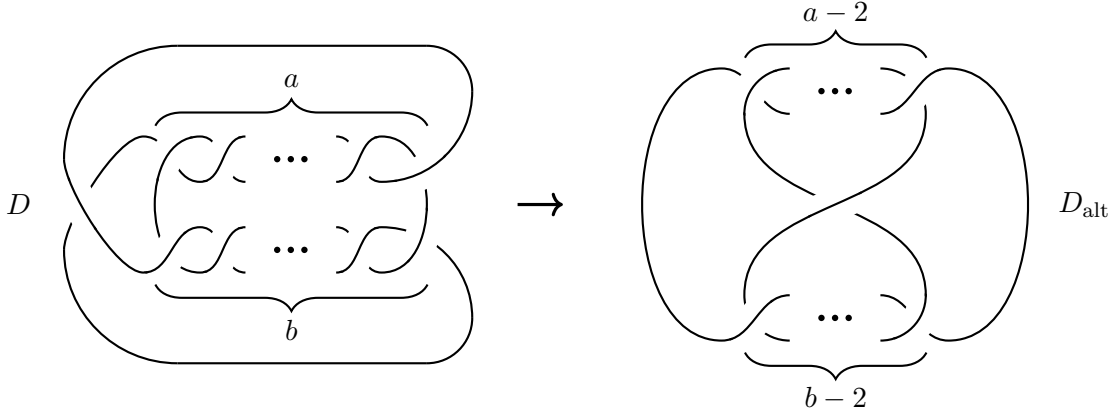

Figure 12: The link diagram D can be transformed into the alternating diagram D_{alt} .

Corollary 4.5. *Let L be a non-split link.*

(1) If L is A -almost alternating, then there is an $i_0 \in \mathbb{Z}$ such that

$$Kh^{*,j_{\min}(L)}(L) = Kh^{i_0(L),j_{\min}(L)}(L) \cong \mathbb{Z}$$

and $2i_0(L) - j_{\min}(L) = \delta_{\min}(L) + 2$.

(2) If L is B -almost alternating, then there is an $i_0 \in \mathbb{Z}$ such that

$$Kh^{*,j_{\max}(L)}(L) = Kh^{i_0(L),j_{\max}(L)}(L) \cong \mathbb{Z}$$

and $2i_0(L) - j_{\max}(L) = \delta_{\max}(L) - 2$.

Proof. Let D be an A -almost alternating diagram of L . Theorem 4.4 and Equation 2.1 imply that $j_{\min}(L) = 2 - s_A(D) + c_+(D) - 2c_-(D)$ and that

$$Kh^{*,j_{\min}(L)}(L) = Kh^{1-c_-(D),j_{\min}(L)}(L) \cong \mathbb{Z}.$$

Thus $2i_0(L) - j_{\min}(L) = 2(1 - c_-(D)) - (2 - s_A(D) + c_+(D) - 2c_-(D)) = s_A(D) - c_+(D)$. Since $Kh^{*,j}(L) = 0$ when $j < j_{\min}(L)$, Theorems 2.3 and 3.1 imply that either $Kh^{i_0(L),j_{\min}(L)+2}(L)$ or $Kh^{i_0(L)+1,j_{\min}(L)+4}(L)$ are nontrivial. Thus $\delta_{\min}(L) = s_A(D) - c_+(D) - 2$ and $2i_0(L) - j_{\min}(L) = \delta_{\min}(L) + 2$.

The case where L is B -almost alternating is similar. \square

Proof of Theorem 1.3. If L is A -adequate, then Theorem 4.1 is the desired result. If L is A -almost alternating, then Corollary 4.5 is the desired result. If L is A -Turaev genus one, then L is either A -adequate or A -almost alternating. The case where L is B -Turaev genus one is handled similarly. \square

Corollary 1.4 follows from Theorem 1.3 and Corollary 3.6.

Proof of Corollary 1.4. Let L be a non-split link with Turaev genus one. Corollary 3.6 implies that L is A -Turaev genus one or B -Turaev genus one. If L is A -Turaev genus one, then Theorem 1.3 implies $Kh^{*,j_{\min}(L)}(L) \cong \mathbb{Z}$, and if L is B -Turaev genus one, then Theorem 1.3 implies $Kh^{*,j_{\max}(L)}(L) \cong \mathbb{Z}$. \square

Let $Kh_{\text{odd}}(L)$ denote the odd Khovanov homology of the link L . The following theorem is a version of Theorem 1.3 for $Kh_{\text{odd}}(L)$.

Theorem 4.6. *Suppose that L is a non-split link.*

- (1) *If L is A -Turaev genus one, then the minimum quantum gradings of $Kh(L)$ and $Kh_{\text{odd}}(L)$ are equal, and there is an $i_0 \in \mathbb{Z}$ such that $Kh_{\text{odd}}^{*,j_{\min}(L)}(L) = Kh_{\text{odd}}^{i_0,j_{\min}(L)}(L) \cong \mathbb{Z}$ and $2i_0 - j_{\min}(L) = \delta_{\min}(L) + 2$.*
- (2) *If L is B -Turaev genus one, then the maximum quantum grading of $Kh(L)$ and $Kh_{\text{odd}}(L)$ are equal, and there is an $i_0 \in \mathbb{Z}$ such that $Kh_{\text{odd}}^{*,j_{\max}(L)}(L) = Kh_{\text{odd}}^{i_0,j_{\max}(L)}(L) \cong \mathbb{Z}$ and $2i_0 - j_{\max}(L) = \delta_{\max}(L) - 2$.*

Proof. Suppose that L is almost alternating. The proofs of Theorem 4.2, Lemma 4.3, Theorem 4.4, and Corollary 4.5 rely on gradings in the Khovanov chain complex, the fact that both extremal Khovanov homology groups of an alternating link are isomorphic to \mathbb{Z} , and the long exact sequence of Theorem 2.2. Since the chain groups for odd Khovanov homology are isomorphic to the chain groups for Khovanov homology, the extremal odd Khovanov homology groups of an alternating link are isomorphic to \mathbb{Z} , and the long exact sequences of Theorem 2.2 also hold in the odd Khovanov setting, Corollary 4.5 holds for odd Khovanov homology. Thus the desired result holds for almost alternating links.

Bloom [Blo10] proved that odd Khovanov homology is mutation invariant. Armond and Lowrance [AL17] proved that if L is a Turaev genus one link, then there is a sequence of mutations transforming L into an almost alternating link. Therefore the desired result holds for Turaev genus one links. \square

5. EXAMPLES

In the next few examples, we give computations of Khovanov homology. The Khovanov homology is presented via a grid where the summand $Kh^{i,j}(L)$ is represented in the (i, j) cell of the grid. A summand of \mathbb{Z}^k is represented by k , a summand of \mathbb{Z}_p^k is represented by k_p , and different summands

in the same bigrading are separated by commas. All Khovanov homology computations in the examples were performed using the KnotTheory Mathematica package [BNMea].

Example 5.1. Let $K = 10_{132} \# \overline{10_{132}}$ be the connected sum of the knot 10_{132} and its mirror, as in Figure 13. Both the leading and trailing coefficients of the Jones polynomial of K are -1 , and hence the results of [DL18] do not apply. However, both Khovanov groups in the minimal and maximal quantum gradings have rank two. Therefore Theorem 1.3 implies that K is inadequate and has Turaev genus and dealternating number at least two. Since the Khovanov homology of K lies on four diagonals, this knot was known to be of Turaev genus and dealternating number at least two by [Man06], [CKS07], and [AP04].

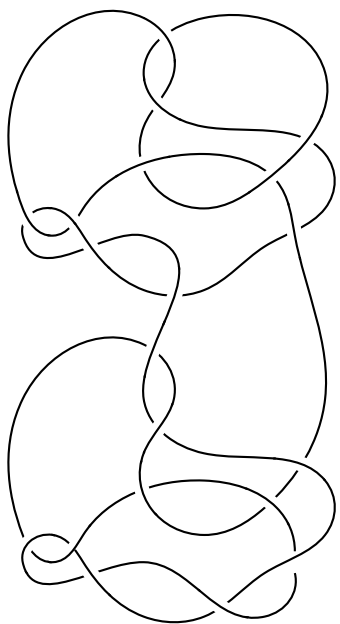

$j \setminus i$	-7	-6	-5	-4	-3	-2	-1	0	1	2	3	4	5	6	7
13														1	1
11													1	1 ₂	1 ₂
9												2	3,1 ₂	1	
7										1	5	3,2 ₂	2 ₂		
5									1	3,1 ₂	3,5 ₂	2,2 ₂			
3								1	7,1 ₂	8,3 ₂	2,1 ₂				
1							3	8,1 ₂	4,6 ₂	1,3 ₂					
-1					1	4,3 ₂	8,6 ₂	3,1 ₂							
-3				2	8,1 ₂	7,3 ₂	1,1 ₂								
-5			2	3,2 ₂	3,5 ₂	1,1 ₂									
-7			3,2 ₂	5,2 ₂	1										
-9		1	3	2,1 ₂											
-11		1 ₂	1,1 ₂												
-13	1	1													

Figure 13: The knot $10_{132} \# \overline{10_{132}}$ and its Khovanov homology.

Example 5.2. The link $L = L11n376$ and its Khovanov homology are depicted in Figure 14. The Khovanov homology of L in its maximal quantum grading has rank two, and thus the link is not B -adequate, B -almost alternating, or B -Turaev genus one. The Khovanov homology in its minimal quantum grading has rank one. Also, $i_0(L) = -7$, $j_{\min}(L) = -19$, and $\delta_{\min}(L) = 1$. Therefore

$$2i_0(L) - j_{\min}(L) = 5 \neq 3 = \delta_{\min}(L) + 2.$$

Theorem 1.3 implies that L is also not A -adequate, A -almost alternating, or A -Turaev genus one. Therefore L is inadequate and has Turaev genus and dealternating number at least two.

Example 5.3. There are four 13 crossing knots with extremal Khovanov homology similar to that of $L11n376$. For each of these knots $Kh^{*,j_{\min}(K)}(K)$ has rank two while $Kh^{*,j_{\max}(K)}(K)$ has rank one. However, in each case $2i_0(K) - j_{\max}(K) \neq \delta_{\max}(K) - 2$. Therefore, the knots listed in Table 1 are inadequate and have Turaev genus and dealternating number at least two.

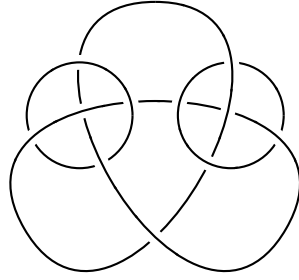

$j \setminus i$	-7	-6	-5	-4	-3	-2	-1	0
-3								2
-5							1	2
-7						2	1_2	
-9				1	1	$1, 2_2$		
-11				4	$2, 1_2$			
-13				$2, 2_2$				
-15		1	2					
-17		1_2						
-19	1							

Figure 14: The link L11n376 and its Khovanov homology.

Name	i_0	j_{\max}	δ_{\max}
$13n_{588}$	8	23	-3
$13n_{1907}$	8	23	-3
$13n_{2492}$	7	21	-3
$13n_{2533}$	4	11	1

TABLE 1. Knots with 13 crossings whose Khovanov homology does not satisfy Theorem 1.3.

6. SIGNATURE AND EXTREMAL KHOVANOV HOMOLOGY

In this section, we prove Theorem 1.7 and conjecture a generalization of it in Conjecture 6.1.

Proof of 1.7. If L is a non-split alternating link with reduced diagram D , then Traczyk [Tra04] proved that

$$\sigma(L) = s_A(D) - c_+(D) - 1 = -s_B(D) + c_-(D) + 1.$$

Dasbach and Lowrance [DL18] proved that if D is a Turaev genus one diagram of the link L , then

$$(6.1) \quad \sigma(L) = s_A(D) - c_+(D) \pm 1.$$

Suppose that D is both A -Turaev genus one and B -Turaev genus one. Theorem 1.3 and Corollary 4.5 imply that both $Kh^{*,j_{\min}(L)}(L) \cong \mathbb{Z}$ and $Kh^{*,j_{\max}(L)}(L) \cong \mathbb{Z}$, and moreover $2i_0(L) - j_{\min}(L) = s_A(D) - c_+(D) = 2i_0(L) - j_{\max}(L)$. Equation 6.1 then implies the result. \square

We conjecture that the hypotheses of Theorem 1.7 can be weakened as follows without changing the conclusion.

Conjecture 6.1. *Suppose L is a non-split Turaev genus one link. At least one of the following statements hold.*

- (1) *There is an $i_0 \in \mathbb{Z}$ such that $Kh^{*,j_{\min}(L)}(L) = Kh^{i_0(L),j_{\min}(L)}(L) \cong \mathbb{Z}$ and $2i_0(L) - j_{\min}(L) = \sigma(L) + 1$.*
- (2) *There is an $i_0 \in \mathbb{Z}$ such that $Kh^{*,j_{\max}(L)}(L) = Kh^{i_0(L),j_{\max}(L)}(L) \cong \mathbb{Z}$ and $2i_0(L) - j_{\max}(L) = \sigma(L) - 1$.*

Conjecture 6.1 is open for links that are A -Turaev genus one, but not B -Turaev genus one (and vice versa). All knots with twelve or fewer crossings that are known to be Turaev genus one satisfy the conjecture. We end the section with an example that would not be Turaev genus one (hence, not almost alternating) assuming that Conjecture 6.1 is true.

Example 6.2. The 12 crossing non-alternating knots $12n_{809}$ and $12n_{835}$ have signatures $\sigma(12n_{809}) = -2$ and $\sigma(12n_{835}) = 0$. Their Khovanov homologies are rank two in the maximum quantum grading and rank one in the minimum quantum grading. We have that $i_0(12n_{809}) = -4$ and $j_{\min}(12n_{809}) = -5$, and thus $2i_0(12n_{809}) - j_{\min}(12n_{809}) \neq \sigma(12n_{809}) + 1$. Similarly, $i_0(12n_{835}) = -7$ and $j_{\min}(12n_{835}) = -13$, and thus $2i_0(12n_{835}) - j_{\min}(12n_{835}) \neq \sigma(12n_{835}) + 1$. Therefore, if Conjecture 6.1 holds, the dealternating number and Turaev genus of both $12n_{809}$ and $12n_{835}$ are at least two.

7. THE MAXIMAL THURSTON BENNEQUIN NUMBER OF AN ALMOST ALTERNATING LINK

A Legendrian link in \mathbb{R}^3 with the standard contact structure $dz - y dx$ projects in the xz -plane to a Legendrian front diagram (or simply a front). A front has no vertical tangents, and its singular points are transverse double points and cusps (in place of a vertical tangents). A double point \times in a front diagram should be interpreted as a crossing \ltimes where the segment with negative slope passes over the segment with positive slope.

The *Thurston Bennequin number* $\text{tb}(\mathcal{L})$ of an oriented Legendrian link \mathcal{L} with front diagram F is defined as $\text{tb}(\mathcal{L}) = w(F) - c(F)$ where $w(F)$ is the writhe of the front F and $c(F)$ is half the number of cusps in F . Ng [Ng05] proved that the maximal Thurston Bennequin number of a link has the following upper bound given by Khovanov homology.

Theorem 7.1 (Ng). *Let L be a non-split link. Then*

$$\overline{\text{tb}}(L) \leq \min\{j - i \mid Kh^{i,j}(L) \neq 0\}.$$

Ng used the bound in Theorem 7.1 to prove the following result that we slightly reformulate to match the notation of this paper.

Theorem 7.2 (Ng). *Let L be a non-split alternating link with reduced alternating diagram D . Then*

$$\overline{\text{tb}}(L) = w(D) - s_A(D)$$

where $w(D)$ is the writhe of D and $s_A(D)$ is the number of components in the all- A state of D .

Kálmán [K08] extended Ng's result to A - and B -adequate links by proving the following result.

Theorem 7.3 (Kálmán). *Let L be a link with diagram D . If D is A -adequate, then*

$$\overline{\text{tb}}(L) = w(D) - s_A(D).$$

If D is B -adequate, then

$$\overline{\text{tb}}(\overline{L}) = -w(D) - s_B(D).$$

The proofs of Theorems 7.2 and 7.3 use *Mondrian diagrams*, diagrams consisting of a set of thick disjoint horizontal line segments and a set of thin disjoint vertical line segments such that each vertical segment begins and ends on a horizontal segment and does not intersect any other horizontal segment. Each Mondrian diagram yields a graph embedded in the plane by contracting the horizontal segments into vertices. Ng proved that every plane graph is the contraction of a Mondrian diagram.

We modify Ng's approach to prove Theorem 1.8. Informally, we start with an almost alternating diagram and then construct its checkerboard graph. The vertices of the checkerboard graph are then stretched horizontally to form the thick line segments of a Mondrian diagram. Finally, a Legendrian front diagram is obtained from a Mondrian diagram by replacing thick horizontal line segments with two-cusped unknots and replacing thin vertical line segments with crossings, as in Figure 15. The crossing associated to the dealternator will need to be modified according to Figure 18 in order to obtain a Legendrian front diagram. The resulting Legendrian front diagram has the same checkerboard graph as the original almost alternating diagram, and so the two are isotopic on the projection S^2 . Figure 16 shows this process for an almost alternating diagram of the $(3, 4)$ torus knot.

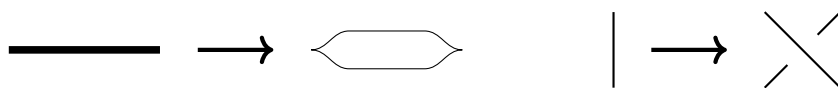

Figure 15: Turning a Mondrian diagram into a Legendrian front diagram.

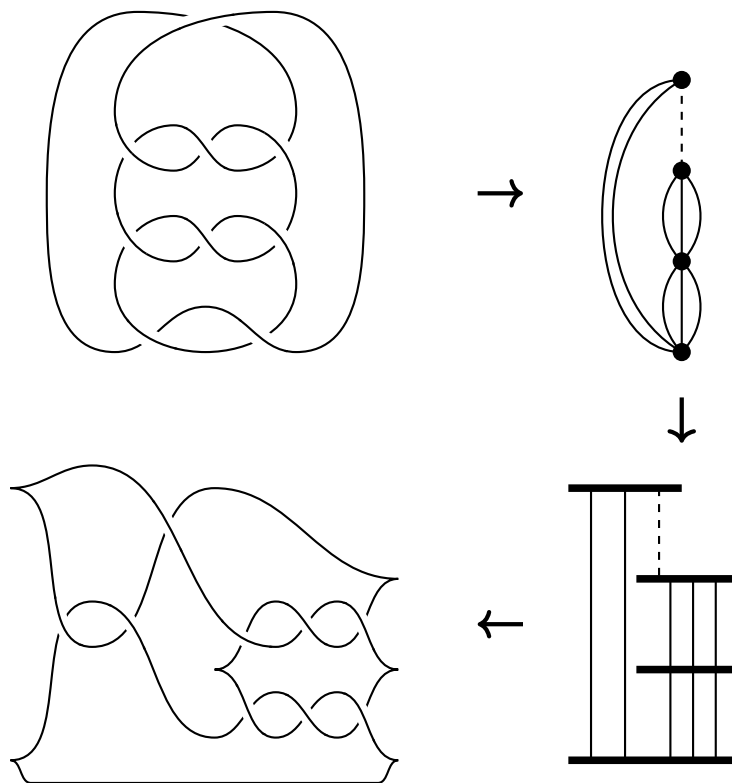

Figure 16: An almost alternating diagram of the $(3, 4)$ torus knot, its checkerboard graph, Mondrian diagram, and Legendrian front diagram.

In order to show the process of Figure 16 can be carried out for an arbitrary almost alternating diagram, we need a lemma about the structure of Mondrian diagrams for almost alternating links. It may be helpful for the reader to consult Ng's proof of Proposition 11 in [Ng05] where he shows that every planar graph is the contraction of a Mondrian diagram.

Lemma 7.4. *Let L be an almost alternating link. There exists an almost alternating diagram D of L and a Mondrian diagram contracting to the checkerboard graph of D such that the vertical edge associated to the dealternator is the leftmost edge on the top of the horizontal segment containing its lower endpoint and is the rightmost edge on the bottom of the horizontal segment containing its upper endpoint.*

Proof. In any almost alternating diagram of L , the edge associated to the dealternator is the unique edge between the two vertices it is incident to. If more than one such edge existed, then, after possibly flyping, the diagram could be transformed into an alternating diagram via a Reidemeister 2 move, as in Figure 5.

First we assume that L is prime, and let D be an almost alternating diagram of L . Color the complementary regions of D in a checkerboard fashion so that the coloring near the dealternator looks like $\begin{smallmatrix} \diagdown \\ \diagup \end{smallmatrix}$ and the coloring near every other crossing looks like $\begin{smallmatrix} \diagup \\ \diagdown \end{smallmatrix}$. Let G be the checkerboard graph of D whose vertices correspond to the shaded regions. Since D is prime, the graph G is 2-connected.

Ng [Ng05, Proposition 11] gives an algorithm that constructs a Mondrian diagram that contracts to G . The algorithm starts by associating a step-shaped cycle in the Mondrian diagram to a cycle of G that bounds a face in its planar embedding (see Figure 17). The algorithm completes the Mondrian diagram by adding vertical edges and adding or extending horizontal edges in the interior of the step shaped cycle. Choose the initial cycle to contain the edge associated to the dealternator, and label the vertices incident to the dealternator edge 1 and 2. Any new horizontal edges can be chosen to be below the horizontal edge labeled 2. Therefore the vertical edge associated to the dealternator is the leftmost edge on the top of the horizontal segment labeled 2 and is the rightmost edge on the bottom of the horizontal segment labeled 1.

Now suppose that L is composite, rather than prime. Then the checkerboard graph of a diagram of L may not be 2-connected. A graph that is not 2-connected can be decomposed into 2-connected pieces, called blocks, glued together at vertices. Changing the vertices where the blocks are glued together corresponds to taking connected sums of link diagrams using different arcs of the diagram. Ng constructs a Mondrian diagram associated to a graph that is not 2-connected by first forming the Mondrian diagram of each block, and then gluing them together by extending and identifying the horizontal lines in the outer step shaped cycle for each block. By carefully choosing what arcs of the diagram are involved in a connected sum operation, we can ensure that there is a A -almost alternating diagram where the vertices incident to the dealternator edge are not part of any other block. Hence the associated Mondrian horizontal edges (edges 1 and 2 in the above construction) are not extended or identified with any other edges. Thus the argument for the prime case extends to the composite case. \square

A Mondrian diagram associated to an alternating link diagram yields a Legendrian front diagram of the link by replacing the thick horizontal lines with two-cusped unknots and replacing thin vertical lines with crossings. We slightly modify this construction to give a Legendrian front diagram of an almost alternating link, and we end the paper with the proof of Theorem 1.8.

Proof of Theorem 1.8. Let D be an A -Turaev genus one diagram. If D is A -adequate, then the result follows from Theorem 7.3. Suppose that D is A -almost alternating.

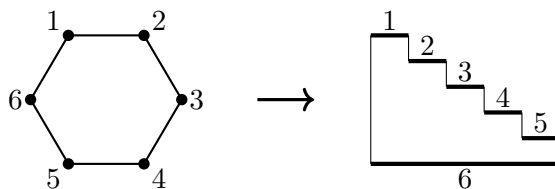

Figure 17: A cycle in G induces a step-shaped cycle in the Mondrian diagram.

Theorem 4.4 and Corollary 4.5 imply that the Khovanov homology of D is nontrivial in homological grading $i_0(L) = 1 - c_-(D)$ and quantum grading $j_{\min}(L) = -s_A(D) + c_+(D) - 2c_-(D)$. Theorem 7.1 then implies that $\overline{\text{tb}}(L) \leq j_{\min}(L) - i_0(L) = w(D) - s_A(D) + 1$. Let D_{alt} be the alternating diagram obtained by performing a crossing change on the dealternator of D . Lemma 7.4 states that D has a Mondrian diagram where the edge associated to the dealternator is the leftmost edge on the horizontal segment containing its bottom endpoint and the rightmost edge on the horizontal segment containing its top endpoint (see the left side of Figure 18). The Mondrian diagram for D is also a Mondrian diagram for D_{alt} . Construct a Legendrian front diagram \mathcal{D}_{alt} as in Figure 15. Theorem 7.2 implies that D_{alt} has Thurston Bennequin number $\text{tb}(\mathcal{D}_{\text{alt}}) = w(D_{\text{alt}}) - s_A(D_{\text{alt}})$. Changing the dealternator crossing of the Legendrian front diagram \mathcal{D}_{alt} results in a diagram D_{alm} of D that is nearly a Legendrian front diagram, but the dealternator has the strand with positive slope passing over the strand with negative slope. Performing the local isotopy in Figure 18 changes D_{alm} into a Legendrian front diagram \mathcal{D}_{alm} of L with two fewer cusps than \mathcal{D}_{alt} . Therefore $\text{tb}(\mathcal{D}_{\text{alm}}) = w(D) - (s_A(D_{\text{alt}}) - 1) = w(D) - s_A(D)$, and hence $w(D) - s_A(D) \leq \overline{\text{tb}}(L)$, proving the result. \square

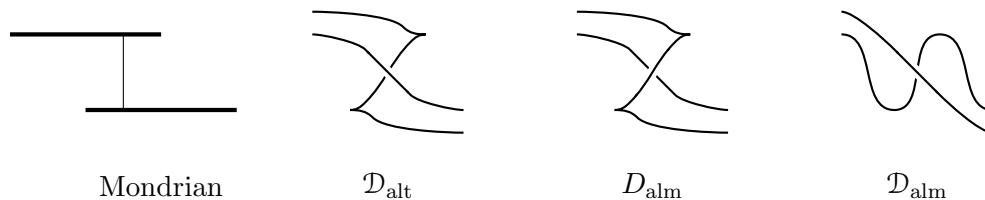

Figure 18: The portion of the Mondrian diagram associated to the dealternator yields the crossing as it looks in the alternating Legendrian diagram \mathcal{D}_{alt} . Changing that crossing gives the no longer Legendrian diagram D_{alm} , but making the pictured local change turns the diagram into the Legendrian front diagram \mathcal{D}_{alm} .

REFERENCES

- [ABB⁺92] Colin C. Adams, Jeffrey F. Brock, John Bugbee, Timothy D. Comar, Keith A. Faigin, Amy M. Huston, Anne M. Joseph, and David Pesikoff, *Almost alternating links*, *Topology Appl.* **46** (1992), no. 2, 151–165.
- [Abe09a] Tetsuya Abe, *An estimation of the alternation number of a torus knot*, *J. Knot Theory Ramifications* **18** (2009), no. 3, 363–379.
- [Abe09b] ———, *The Turaev genus of an adequate knot*, *Topology Appl.* **156** (2009), no. 17, 2704–2712.
- [AK10] Tetsuya Abe and Kengo Kishimoto, *The dealternating number and the alternation number of a closed 3-braid*, *J. Knot Theory Ramifications* **19** (2010), no. 9, 1157–1181.

- [AL17] Cody W. Armond and Adam M. Lowrance, *Turaev genus and alternating decompositions*, *Algebr. Geom. Topol.* **17** (2017), no. 2, 793–830.
- [AP04] Marta M. Asaeda and Józef H. Przytycki, *Khovanov homology: torsion and thickness*, *Advances in topological quantum field theory*, NATO Sci. Ser. II Math. Phys. Chem., vol. 179, Kluwer Acad. Publ., Dordrecht, 2004, pp. 135–166.
- [Arm13] Cody Armond, *The head and tail conjecture for alternating knots*, *Algebr. Geom. Topol.* **13** (2013), no. 5, 2809–2826.
- [Blo10] Jonathan M. Bloom, *Odd Khovanov homology is mutation invariant*, *Math. Res. Lett.* **17** (2010), no. 1, 1–10.
- [BM03] Yongju Bae and Hugh R. Morton, *The spread and extreme terms of Jones polynomials*, *J. Knot Theory Ramifications* **12** (2003), no. 3, 359–373.
- [BN02] Dror Bar-Natan, *On Khovanov’s categorification of the Jones polynomial*, *Algebr. Geom. Topol.* **2** (2002), 337–370.
- [BNMea] Dror Bar-Natan, Scott Morrison, and et al., *The Knot Atlas*, <http://katlas.org>.
- [CK14] Abhijit Champanerkar and Ilya Kofman, *A survey on the Turaev genus of knots*, *Acta Math. Vietnam.* **39** (2014), no. 4, 497–514.
- [CKS07] Abhijit Champanerkar, Ilya Kofman, and Neal Stoltzfus, *Graphs on surfaces and Khovanov homology*, *Algebr. Geom. Topol.* **7** (2007), 1531–1540.
- [DFK⁺08] Oliver T. Dasbach, David Futer, Efstratia Kalfagianni, Xiao-Song Lin, and Neal W. Stoltzfus, *The Jones polynomial and graphs on surfaces*, *J. Combin. Theory Ser. B* **98** (2008), no. 2, 384–399.
- [DFK⁺10] ———, *Alternating sum formulae for the determinant and other link invariants*, *J. Knot Theory Ramifications* **19** (2010), no. 6, 765–782.
- [DL11] Oliver T. Dasbach and Adam M. Lowrance, *Turaev genus, knot signature, and the knot homology concordance invariants*, *Proc. Amer. Math. Soc.* **139** (2011), no. 7, 2631–2645.
- [DL14] ———, *A Turaev surface approach to Khovanov homology*, *Quantum Topol.* **5** (2014), no. 4, 425–486.
- [DL18] ———, *Invariants for Turaev genus one links*, *Comm. Anal. Geom.* **26** (2018), no. 5, 1101–1124.
- [Dow18] Nathan Dowlin, *A spectral sequence from Khovanov homology to knot Floer homology*, arXiv:1811.07848, 2018.
- [FKP13] David Futer, Efstratia Kalfagianni, and Jessica Purcell, *Guts of surfaces and the colored Jones polynomial*, *Lecture Notes in Mathematics*, vol. 2069, Springer, Heidelberg, 2013.
- [FKP14] David Futer, Efstratia Kalfagianni, and Jessica S. Purcell, *Jones polynomials, volume and essential knot surfaces: a survey*, *Knots in Poland. III. Part 1*, Banach Center Publ., vol. 100, Polish Acad. Sci. Inst. Math., Warsaw, 2014, pp. 51–77.
- [FKP15] ———, *Hyperbolic semi-adequate links*, *Comm. Anal. Geom.* **23** (2015), no. 5, 993–1030.
- [GHY01] Hiroshi Goda, Mikami Hirasawa, and Ryosuke Yamamoto, *Almost alternating diagrams and fibered links in S^3* , *Proc. London Math. Soc.* (3) **83** (2001), no. 2, 472–492.
- [GMM11] Juan González-Meneses and Pedro M. G. Manchón, *A geometric characterization of the upper bound for the span of the Jones polynomial*, *J. Knot Theory Ramifications* **20** (2011), no. 7, 1059–1071.
- [GMMS18] J. González-Meneses, P. M. G. Manchón, and M. Silvero, *A geometric description of the extreme Khovanov cohomology*, *Proc. Roy. Soc. Edinburgh Sect. A* **148** (2018), no. 3, 541–557.
- [Gre17] Joshua Evan Green, *Alternating links and definite surfaces*, *Duke Math. J.* (2017), no. 3, 19 pages.
- [How17] Joshua Howie, *A characterisation of alternating knot exteriors*, *Geom. Topol.* **21** (2017), no. 4, 2353–2371.
- [Ito18] Tetsuya Ito, *A characterization of almost alternating knots*, *J. Knot Theory Ramifications* **27** (2018), no. 1, 1850009, 13.
- [JLPZ17] Kaitian Jin, Adam M. Lowrance, Eli Polston, and Yanjie Zheng, *The Turaev genus of torus knots*, *J. Knot Theory Ramifications* **26** (2017), no. 14, 1750095, 28.
- [KÓ8] Tamás Kálmán, *Maximal Thurston-Bennequin number of +adequate links*, *Proc. Amer. Math. Soc.* **136** (2008), no. 8, 2969–2977.
- [Kal18] Efstratia Kalfagianni, *A Jones slopes characterization of adequate knots*, *Indiana Univ. Math. J.* **67** (2018), 205–219, arXiv:1601.03307.
- [Kau87] Louis H. Kauffman, *State models and the Jones polynomial*, *Topology* **26** (1987), no. 3, 395–407.
- [Kau12] ———, *Khovanov homology*, *Introductory lectures on knot theory*, Ser. Knots Everything, vol. 46, World Sci. Publ., Hackensack, NJ, 2012, pp. 248–280.
- [Kho00] Mikhail Khovanov, *A categorification of the Jones polynomial*, *Duke Math. J.* **101** (2000), no. 3, 359–426.
- [Kho03] ———, *Patterns in knot cohomology. I*, *Experiment. Math.* **12** (2003), no. 3, 365–374.

- [Kim16] Seungwon Kim, *A topological characterization of toroidally alternating knots*, arXiv:1608.00521, 2016.
- [Kim18] ———, *Link diagrams with low Turaev genus*, Proc. Amer. Math. Soc. **146** (2018), 875–890, arXiv:1507.02918.
- [KK18] Seungwon Kim and Ilya Kofman, *Turaev surfaces*, To appear in A Concise Encyclopedia of Knot Theory, 2018.
- [KL14] Efstratia Kalfagianni and Christine Ruey Shan Lee, *On the degree of the colored Jones polynomial*, Acta Math. Vietnam. **39** (2014), no. 4, 549–560.
- [Lee02] Eun Soo Lee, *The support of the Khovanov’s invariants for alternating knots*, arXiv:0201105, 2002.
- [Lee05] ———, *An endomorphism of the Khovanov invariant*, Adv. Math. **197** (2005), no. 2, 554–586.
- [Lic97] W. B. Raymond Lickorish, *An introduction to knot theory*, Graduate Texts in Mathematics, vol. 175, Springer-Verlag, New York, 1997.
- [Low08] Adam M. Lowrance, *On knot Floer width and Turaev genus*, Algebr. Geom. Topol. **8** (2008), no. 2, 1141–1162.
- [Low11] Adam Lowrance, *The Khovanov width of twisted links and closed 3-braids*, Comment. Math. Helv. **86** (2011), no. 3, 675–706.
- [Low15] Adam M. Lowrance, *Alternating distances of knots and links*, Topology Appl. **182** (2015), 53–70.
- [Low18] ———, *Alternating distances of knots*, To appear in A Concise Encyclopedia of Knot Theory, 2018.
- [LS17] Adam M. Lowrance and Dean Spyropoulos, *The Jones polynomial of an almost alternating link*, New York J. Math. **23** (2017), 1611–1639.
- [LT88] W. B. R. Lickorish and M. B. Thistlethwaite, *Some links with nontrivial polynomials and their crossing-numbers*, Comment. Math. Helv. **63** (1988), no. 4, 527–539.
- [Man06] V. O. Manturov, *The Khovanov complex and minimal knot diagrams*, Dokl. Akad. Nauk **406** (2006), no. 3, 308–311.
- [MS18] Federico Cantero Morán and Marithania Silvero, *Extreme Khovanov spectra*, 2018, arXiv:1803.06257.
- [Mur87] Kunio Murasugi, *Jones polynomials and classical conjectures in knot theory*, Topology **26** (1987), no. 2, 187–194.
- [Ng05] Lenhard Ng, *A Legendrian Thurston-Bennequin bound from Khovanov homology*, Algebr. Geom. Topol. **5** (2005), 1637–1653.
- [ORS13] Peter S. Ozsváth, Jacob Rasmussen, and Zoltán Szabó, *Odd Khovanov homology*, Algebr. Geom. Topol. **13** (2013), no. 3, 1465–1488.
- [OS03a] Peter Ozsváth and Zoltán Szabó, *Heegaard Floer homology and alternating knots*, Geom. Topol. **7** (2003), 225–254.
- [OS03b] ———, *Knot Floer homology and the four-ball genus*, Geom. Topol. **7** (2003), 615–639.
- [PS18a] Józef H. Przytycki and Marithania Silvero, *Homotopy type of circle graph complexes motivated by extreme Khovanov homology*, J. Algebraic Combin. **48** (2018), no. 1, 119–156.
- [PS18b] Jzef H. Przytycki and Marithania Silvero, *Geometric realization of the almost-extreme Khovanov homology of semiadequate links*, 2018, arXiv:1807.03727.
- [Ras10] Jacob Rasmussen, *Khovanov homology and the slice genus*, Invent. Math. **182** (2010), no. 2, 419–447.
- [Sto11] Alexander Stoimenow, *Coefficients and non-triviality of the Jones polynomial*, J. Reine Angew. Math. **657** (2011), 1–55.
- [Thi87] Morwen B. Thistlethwaite, *A spanning tree expansion of the Jones polynomial*, Topology **26** (1987), no. 3, 297–309.
- [Thi88] ———, *On the Kauffman polynomial of an adequate link*, Invent. Math. **93** (1988), no. 2, 285–296.
- [Tra04] Pawel Traczyk, *A combinatorial formula for the signature of alternating diagrams*, Fund. Math. **184** (2004), 311–316.
- [Tur87] V. G. Turaev, *A simple proof of the Murasugi and Kauffman theorems on alternating links*, Enseign. Math. (2) **33** (1987), no. 3–4, 203–225.
- [Tur16] Paul Turner, *A hitchhiker’s guide to Khovanov homology*, Lectures on quantum topology in dimension three, Panor. Synthèses, vol. 48, Soc. Math. France, Paris, 2016, pp. 91–129.
- [Vir04] Oleg Viro, *Khovanov homology, its definitions and ramifications*, Fund. Math. **184** (2004), 317–342.

DEPARTMENT OF MATHEMATICS, LOUISIANA STATE UNIVERSITY, BATON ROUGE, LA
E-mail address: kasten@math.lsu.edu

DEPARTMENT OF MATHEMATICS, VASSAR COLLEGE, POUGHKEEPSIE, NY
E-mail address: adlowrance@vassar.edu